

CÉRÀGRÈS
LUXE

WALKS



I toni caldi di questa pietra calcarea, oltre alla tecnologia superficiale Super Touch, rivelano alti e bassi rilievi in tutto il pezzo, evidenziando gli elementi che compongono questa pietra calcarea. Fossili e sedimenti marini caratterizzano il calcare tradizionale. "Walks" Stone recupera questo materiale millenario con una qualità estetica e un mood francese senza tempo. Una collezione ampia e versatile è presentata in quattro tonalità tenui disponibili in una vasta gamma di formati. Il gres porcellanato "Walks" regala superfici naturali per progetti ricchi di identità.

The warm tones of this limestone in addition with a Super Touch surface technology reveal high and low reliefs throughout the piece, highlighting the elements that make up this limestone. Fossils and marine sediments characterize traditional limestone. "Walks" Stone rescues this millennial material with a timeless French aesthetic quality and mood. A wide, versatile collection is presented in four soft shades available in a vast array of sizes. "Walks" porcelain stoneware, provides natural surfaces for projects full of identity.

Les tons chauds de ce calcaire associés à une technologie de surface Super Touch révèlent des hauts et des bas reliefs dans toute la pièce, mettant en valeur les éléments qui composent ce calcaire. Les fossiles et les sédiments marins caractérisent le calcaire traditionnel. "Walks" Stone sauve ce matériau millénaire avec une qualité esthétique et une ambiance française intemporelle. Une collection large et polyvalente est présentée en quatre teintes douces disponibles dans une vaste gamme de tailles. Le grès cérame "Walks", offre des surfaces naturelles pour des projets pleins d'identité.

Los tonos cálidos de esta piedra caliza además de una tecnología superficial Super Touch revelan relieves altos y bajos en toda la pieza, resaltando los elementos que componen esta piedra caliza. Los fósiles y sedimentos marinos caracterizan la piedra caliza tradicional. "Walks" Stone rescata este material milenario con una calidad y un tono estético atemporal francés. Una colección amplia y versátil se presenta en cuatro tonos suaves disponibles en una amplia gama de tamaños. El gres porcelánico "Walks", aporta superficies naturales para proyectos llenos de identidad.

WALKS



pavimento Walks Camel 80x80

WALKS

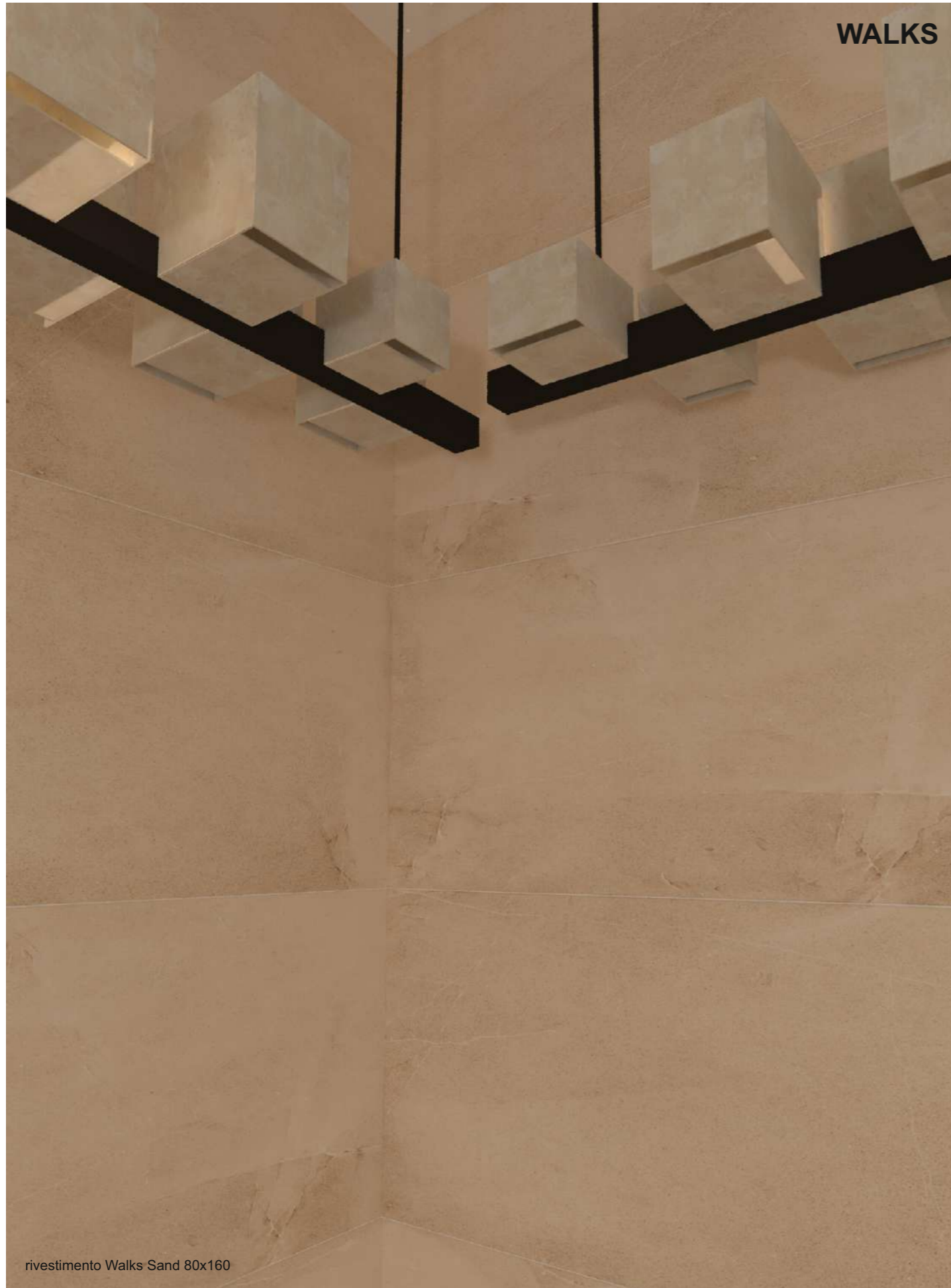

rivestimento Walks Sand 80x160

WALKS

Colori . Colours . Couleurs . Colores



Sand

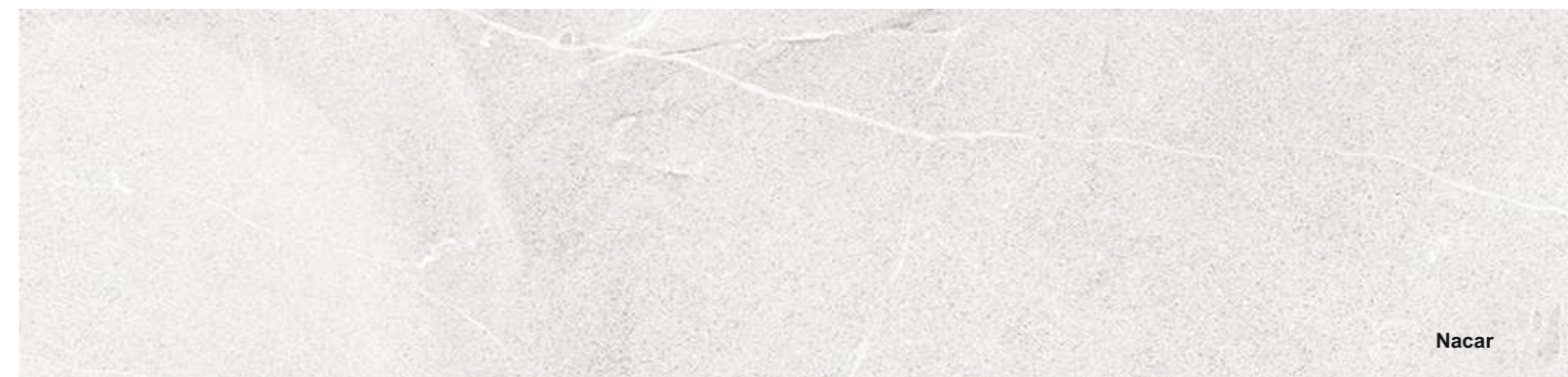

Nacar



Camel



Cemento

WALKS

Formati . Sizes . Formats . Formatos



80x160 R
32"x64"
771701 Walks Sand
771702 Walks Nacar
771703 Walks Camel
771704 Walks Cemento

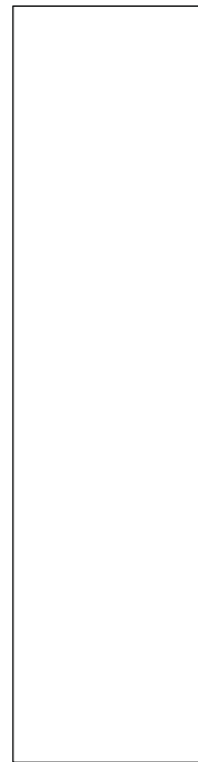

40x160 R
16"x64"
771705 Walks Sand
771706 Walks Nacar
771707 Walks Camel
771708 Walks Cemento



20x160 R
8"x64"
771709 Walks Sand
771710 Walks Nacar
771711 Walks Camel
771712 Walks Cemento



10x160 R
4"x64"
771713 Walks Sand
771714 Walks Nacar
771715 Walks Camel
771716 Walks Cemento

WALKS

Formati . Sizes . Formats . Formatos

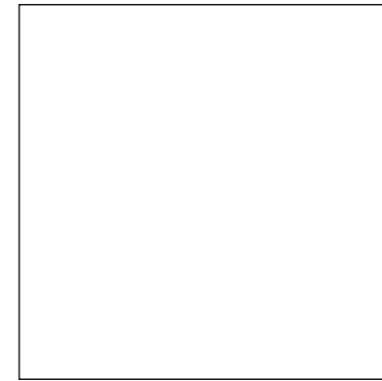

80x80 R
32"x32"
771717 Walks Sand
771718 Walks Nacar
771719 Walks Camel
771720 Walks Cemento

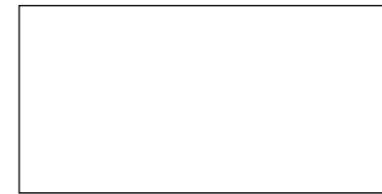

40x80 R
16"x32"
771721 Walks Sand
771722 Walks Nacar
771723 Walks Camel
771724 Walks Cemento



20x80 R
8"x32"
771725 Walks Sand
771726 Walks Nacar
771727 Walks Camel
771728 Walks Cemento



10x80 R
4"x32"
771729 Walks Sand
771730 Walks Nacar
771731 Walks Camel
771732 Walks Cemento

WALKS

Formati . Sizes . Formats . Formatos

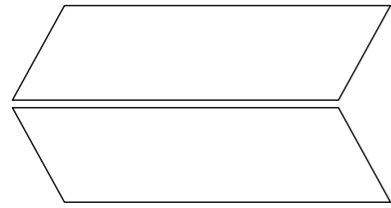

20x80 R
8"x32"
771733 Walks Sand L
771734 Walks Sand R
771735 Walks Nacar L
771736 Walks Nacar R
771737 Walks Camel L
771738 Walks Camel R
771739 Walks Cemento L
771740 Walks Cemento R

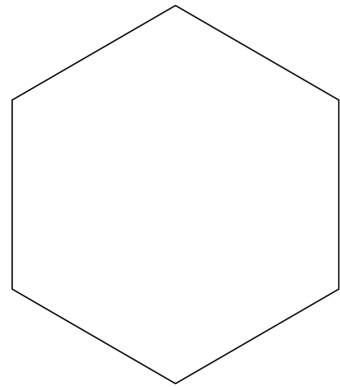

70x80 R
28"x32"
771741 Walks Sand
771742 Walks Nacar
771743 Walks Camel
771744 Walks Cemento

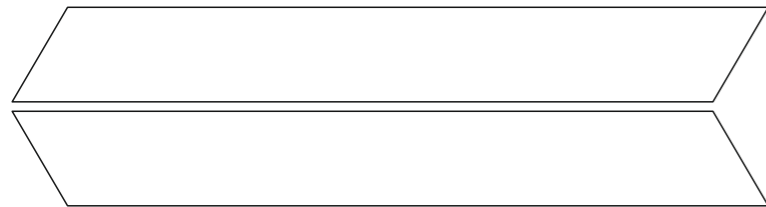

20x160 R
8"x64"
771795 Walks Sand L
771796 Walks Sand R
771797 Walks Nacar L
771798 Walks Nacar R
771799 Walks Camel L
771800 Walks Camel R
771801 Walks Cemento L
771802 Walks Cemento R

WALKS

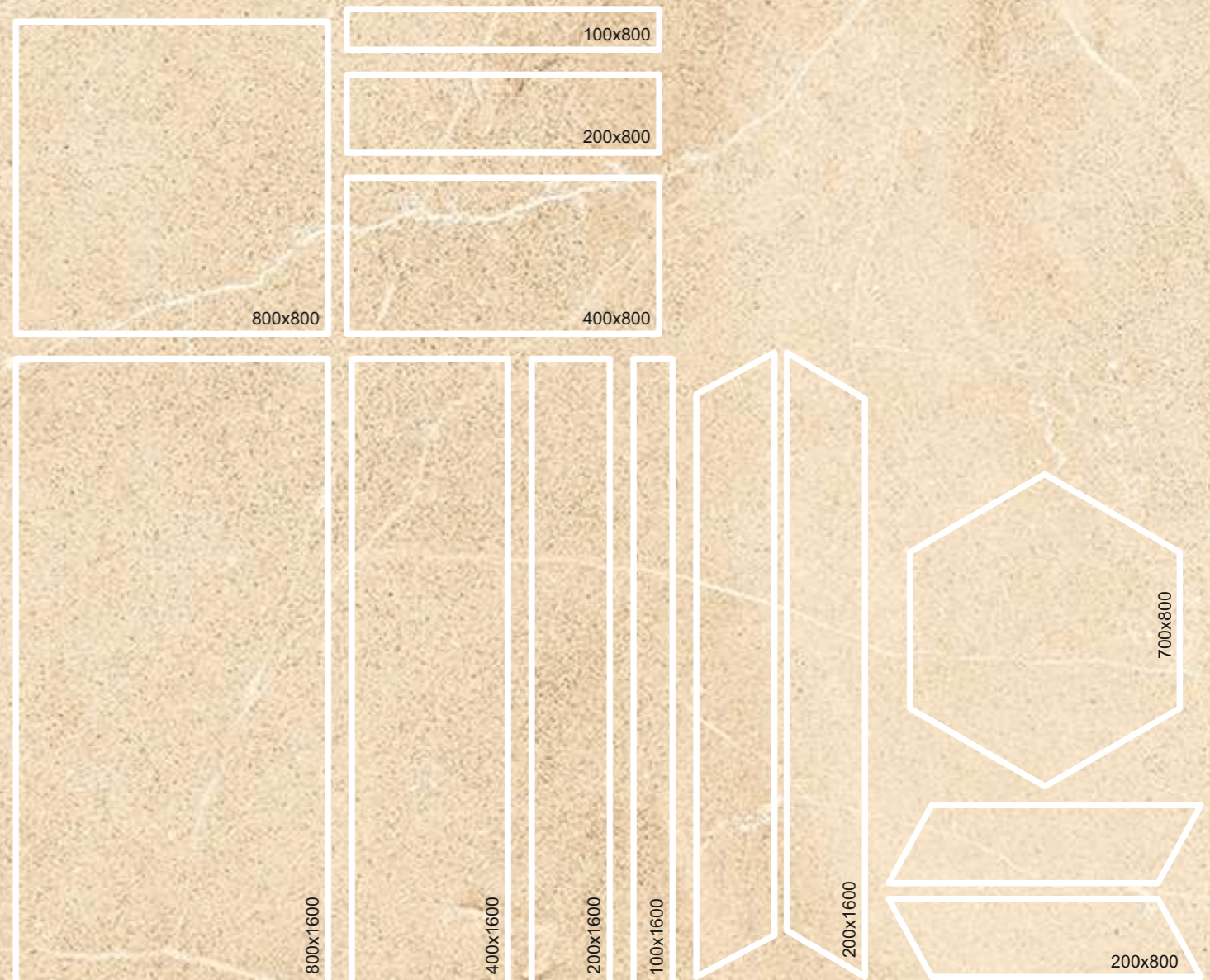

WALKS

Formati . Sizes . Formats . Formatos



80x160 R
32"x64"
771701 Walks Sand

A160

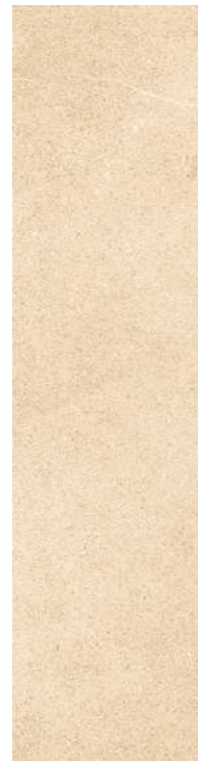

40x160 R
16"x64"
771705 Walks Sand

A150



20x160 R
8"x64"
771709 Walks Sand

A140



10x160 R
4"x64"
771713 Walks Sand

A130



Si consiglia la posa con fuga 2 mm. - Laying with a 2 mm-joint is recommended. - Pose recommandée avec joints de 2 mm. - Se recomienda la colocación con juntas de 2 mm.

WALKS

Formati . Sizes . Formats . Formatos



80x80 R
32"x32"
771717 Walks Sand

A120



40x80 R
16"x32"
771721 Walks Sand

A110



20x80 R
8"x32"
771725 Walks Sand

A100



10x80 R
4"x32"
771729 Walks Sand

A90



Si consiglia la posa con fuga 2 mm. - Laying with a 2 mm-joint is recommended. - Pose recommandée avec joints de 2 mm. - Se recomienda la colocación con juntas de 2 mm.

WALKS



WALKS

Formati . Sizes . Formats . Formatos



Naturale/Matt

20x80 R
8"x32"
771733 Walks Sand L
771734 Walks Sand R

A590



Naturale/Matt

70x80 R
28"x32"
771741 Walks Sand

A640



Naturale/Matt

20x160 R
8"x64"
771795 Walks Sand L
771796 Walks Sand R

A700



Si consiglia la posa con fuga 2 mm. - Laying with a 2 mm-joint is recommended. - Pose recommandée avec joints de 2 mm. - Se recomienda la colocación con juntas de 2 mm.

WALKS

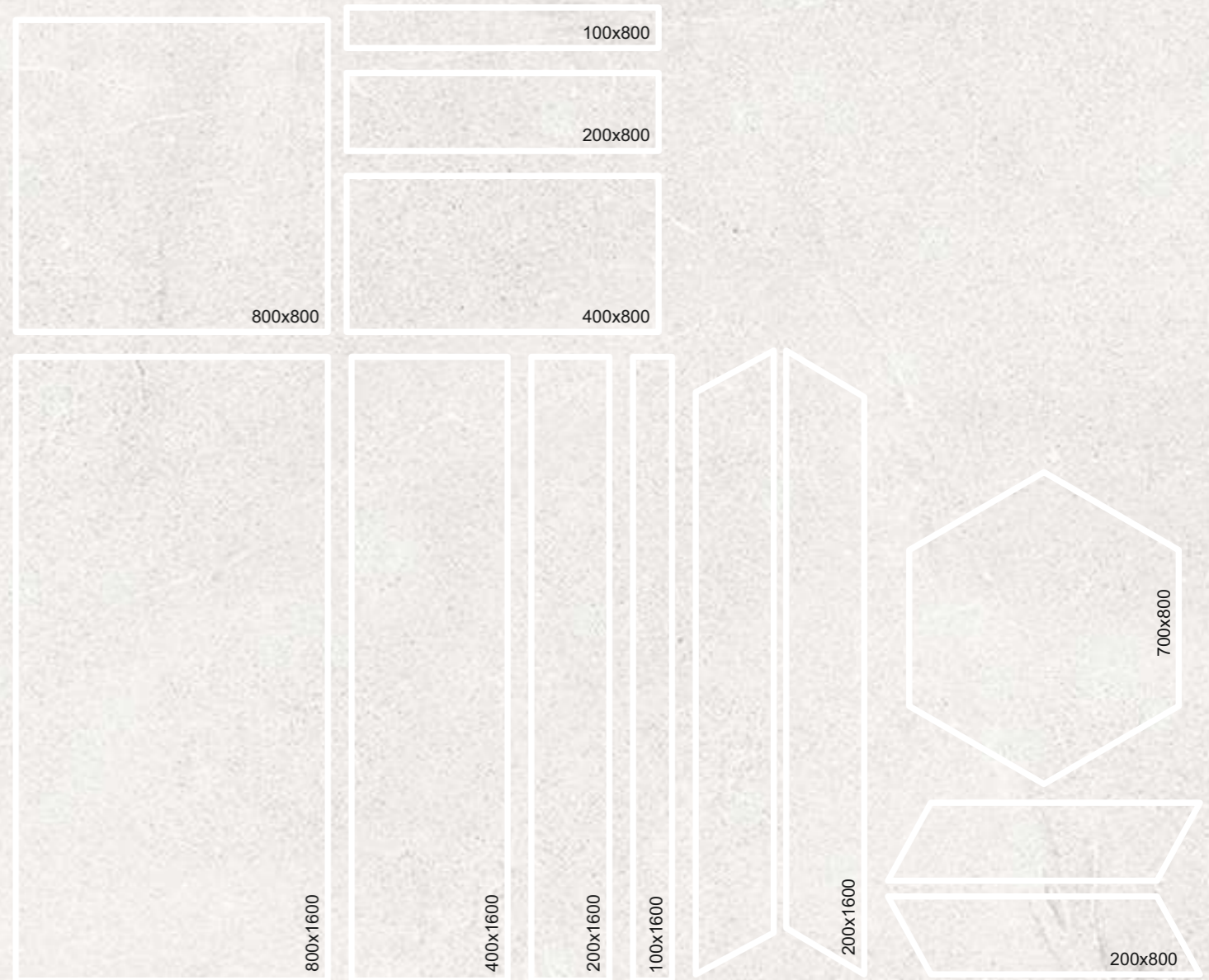

WALKS

Formati . Sizes . Formats . Formatos



80x160 R
32"x64"
771702 Walks Nacar

A160

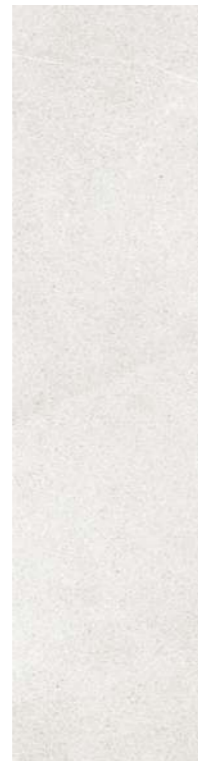

40x160 R
16"x64"
771706 Walks Nacar

A150

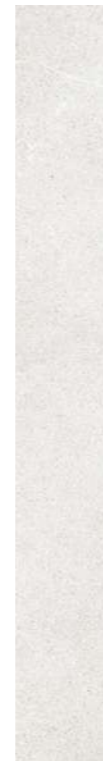

20x160 R
8"x64"
771710 Walks Nacar

A140



10x160 R
4"x64"
771714 Walks Nacar

A130



Si consiglia la posa con fuga 2 mm. - Laying with a 2 mm-joint is recommended. - Pose recommandée avec joints de 2 mm. - Se recomienda la colocación con juntas de 2 mm.

WALKS

Formati . Sizes . Formats . Formatos



80x80 R
32"x32"
771718 Walks Nacar

A120



40x80 R
16"x32"
771722 Walks Nacar

A110



20x80 R
8"x32"
771726 Walks Nacar

A100



10x80 R
4"x32"
771730 Walks Nacar

A90



Si consiglia la posa con fuga 2 mm. - Laying with a 2 mm-joint is recommended. - Pose recommandée avec joints de 2 mm. - Se recomienda la colocación con juntas de 2 mm.



rivestimento Walks Camel 20x80
pavimento Walks Camel 80x80

WALKS

WALKS

Formati . Sizes . Formats . Formatos



Naturale/Matt

20x80 R
8"x32"
771735 Walks Nacar L
771736 Walks Nacar R

A590



Naturale/Matt

70x80 R
28"x32"
771742 Walks Nacar

A640

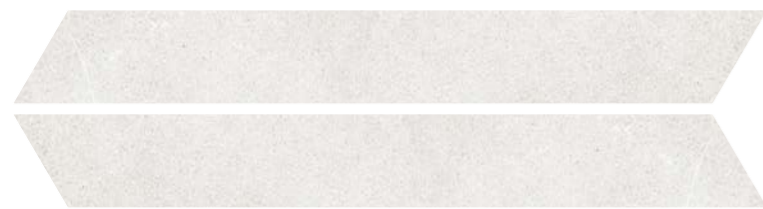

Naturale/Matt

20x160 R
8"x64"
771797 Walks Nacar L
771798 Walks Nacar R

A700

Si consiglia la posa con fuga 2 mm. - Laying with a 2 mm-joint is recommended. - Pose recommandée avec joints de 2 mm. - Se recomienda la colocación con juntas de 2 mm.

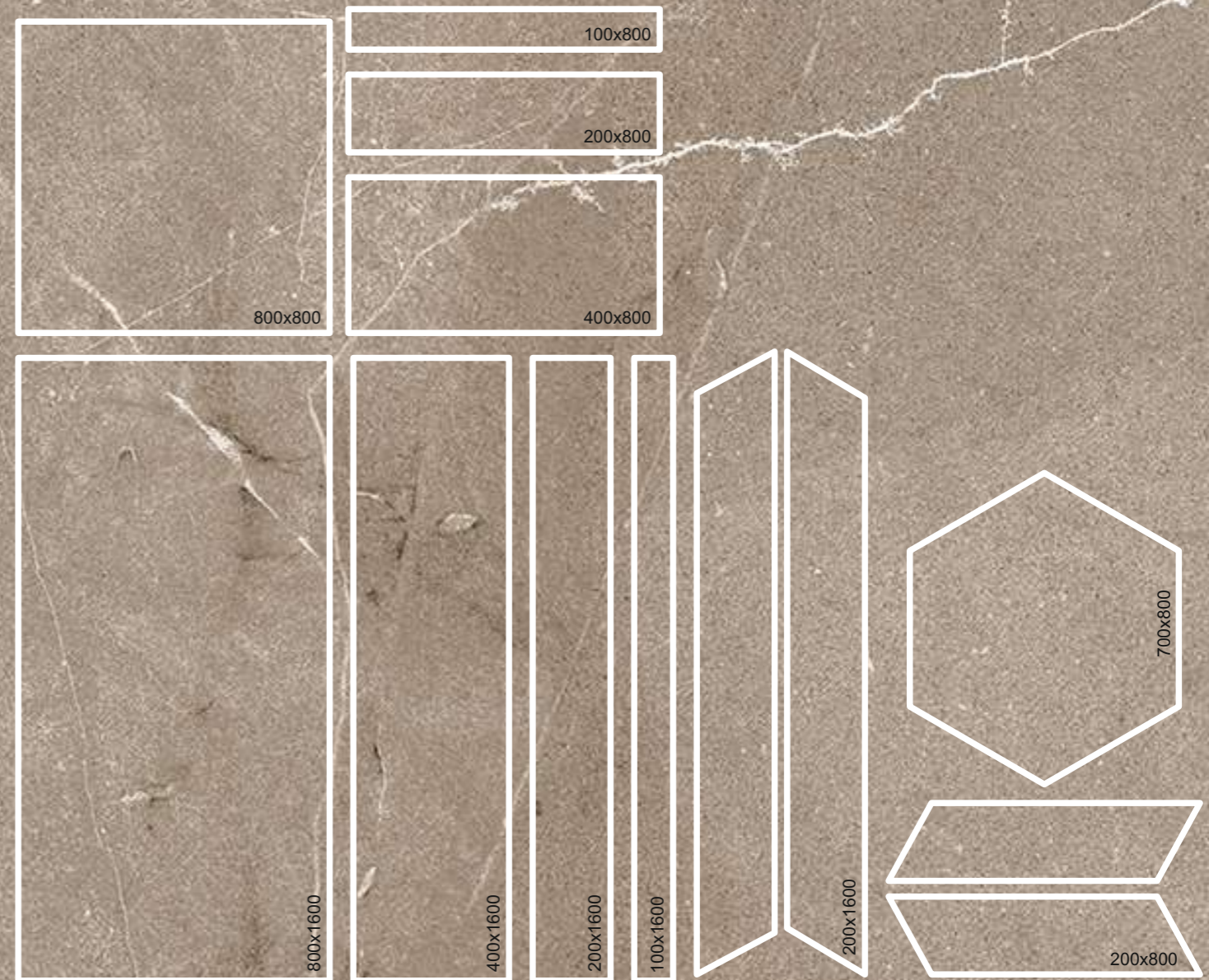

WALKS

Formati . Sizes . Formats . Formatos



80x160 R
32"x64"
771703 Walks Camel

A160



40x160 R
16"x64"
771707 Walks Camel

A150



20x160 R
8"x64"
771711 Walks Camel

A140



10x160 R
4"x64"
771715 Walks Camel

A130



Si consiglia la posa con fuga 2 mm. - Laying with a 2 mm-joint is recommended. - Pose recommandée avec joints de 2 mm. - Se recomienda la colocación con juntas de 2 mm.

WALKS

Formati . Sizes . Formats . Formatos



80x80 R
32"x32"
771719 Walks Camel

A120



40x80 R
16"x32"
771723 Walks Camel

A110



20x80 R
8"x32"
771727 Walks Camel

A100



10x80 R
4"x32"
771731 Walks Camel

A90



Si consiglia la posa con fuga 2 mm. - Laying with a 2 mm-joint is recommended. - Pose recommandée avec joints de 2 mm. - Se recomienda la colocación con juntas de 2 mm.

WALKS

WALKS

Formati . Sizes . Formats . Formatos



20x80 R
8"x32"
771737 Walks Camel L
771738 Walks Camel R

A590



70x80 R
28"x32"
771743 Walks Camel

A640

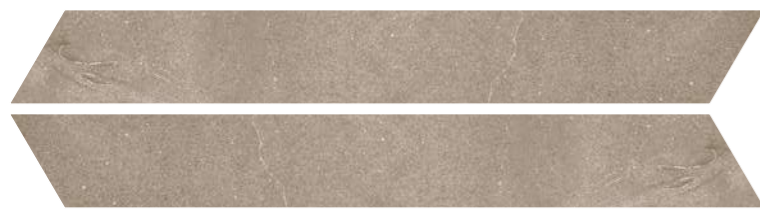

20x160 R
8"x64"
771799 Walks Camel L
771800 Walks Camel R

A700



Si consiglia la posa con fuga 2 mm. - Laying with a 2 mm-joint is recommended. - Pose recommandée avec joints de 2 mm. - Se recomienda la colocación con juntas de 2 mm.

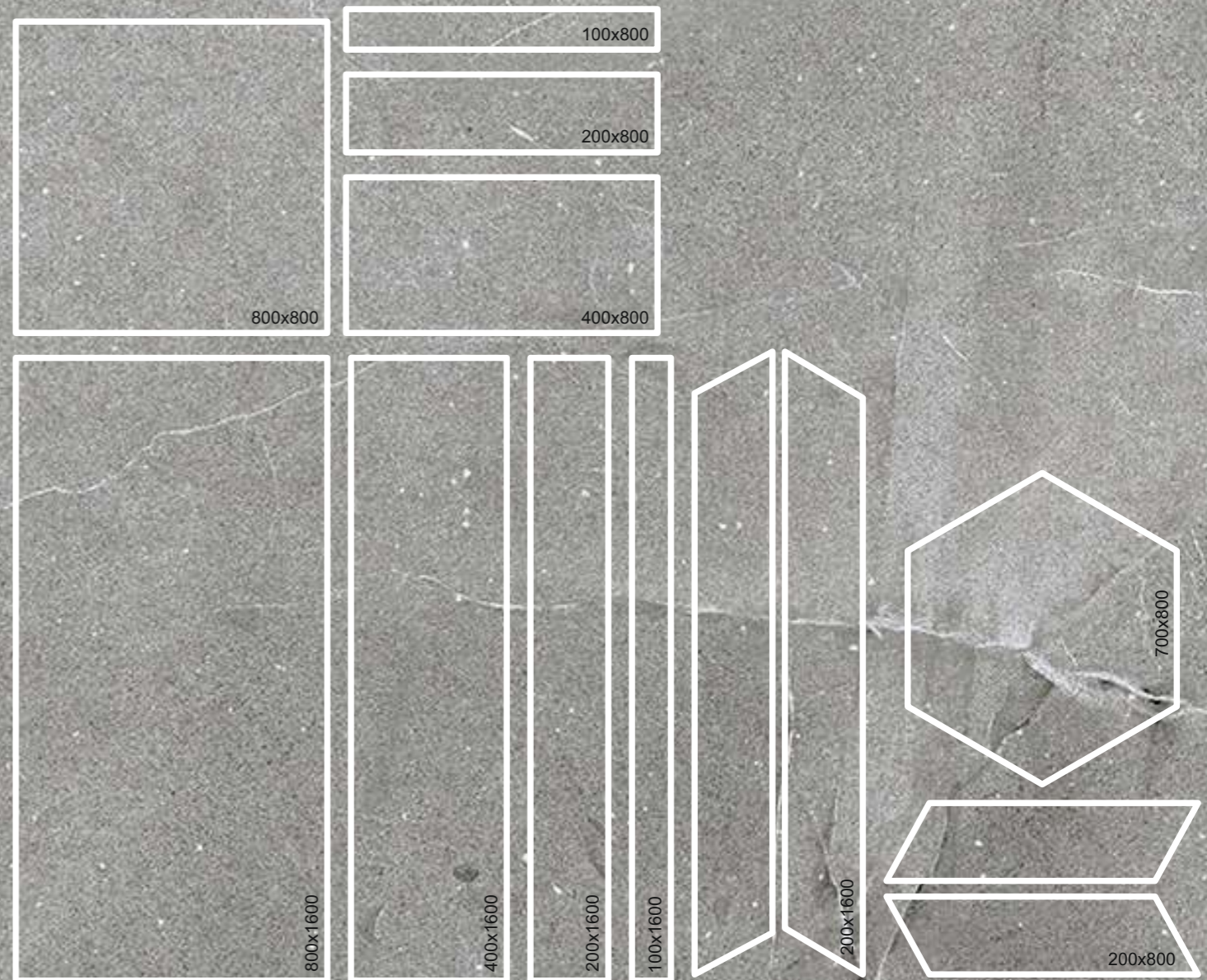

WALKS

Formati . Sizes . Formats . Formatos



80x160 R
32"x64"
771704 Walks Cemento

A160



40x160 R
16"x64"
771708 Walks Cemento

A150



20x160 R
8"x64"
771712 Walks Cemento

A140



10x160 R
4"x64"
771716 Walks Cemento

A130



Si consiglia la posa con fuga 2 mm. - Laying with a 2 mm-joint is recommended. - Pose recommandée avec joints de 2 mm. - Se recomienda la colocación con juntas de 2 mm.

WALKS

Formati . Sizes . Formats . Formatos

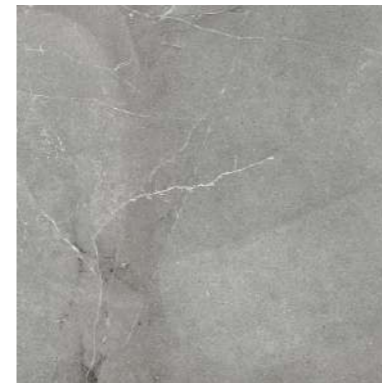

80x80 R
32"x32"
771720 Walks Cemento

A120



40x80 R
16"x32"
771724 Walks Cemento

A110



20x80 R
8"x32"
771728 Walks Cemento

A100



10x80 R
4"x32"
771732 Walks Cemento

A90



Si consiglia la posa con fuga 2 mm. - Laying with a 2 mm-joint is recommended. - Pose recommandée avec joints de 2 mm. - Se recomienda la colocación con juntas de 2 mm.

WALKS

WALKS

Formati . Sizes . Formats . Formatos

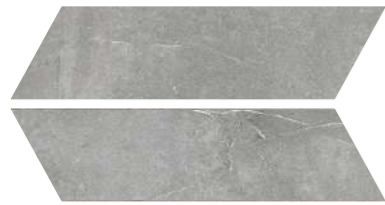

20x80 R
8"x32"
771739 Walks Cemento L
771740 Walks Cemento R

A590



70x80 R
28"x32"
771744 Walks Cemento

A640

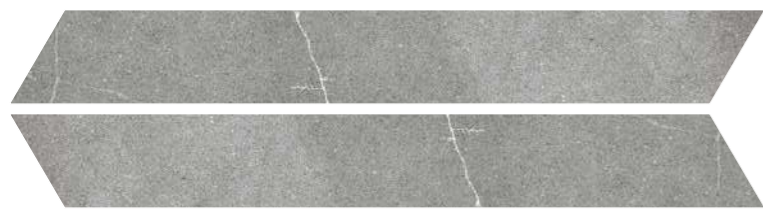

20x160 R
8"x64"
771801 Walks Cemento L
771802 Walks Cemento R

A700

Si consiglia la posa con fuga 2 mm. - Laying with a 2 mm-joint is recommended. - Pose recommandée avec joints de 2 mm. - Se recomienda la colocación con juntas de 2 mm.



rivestimento Walks Camel 20x80
pavimento Walks Camel 80x80

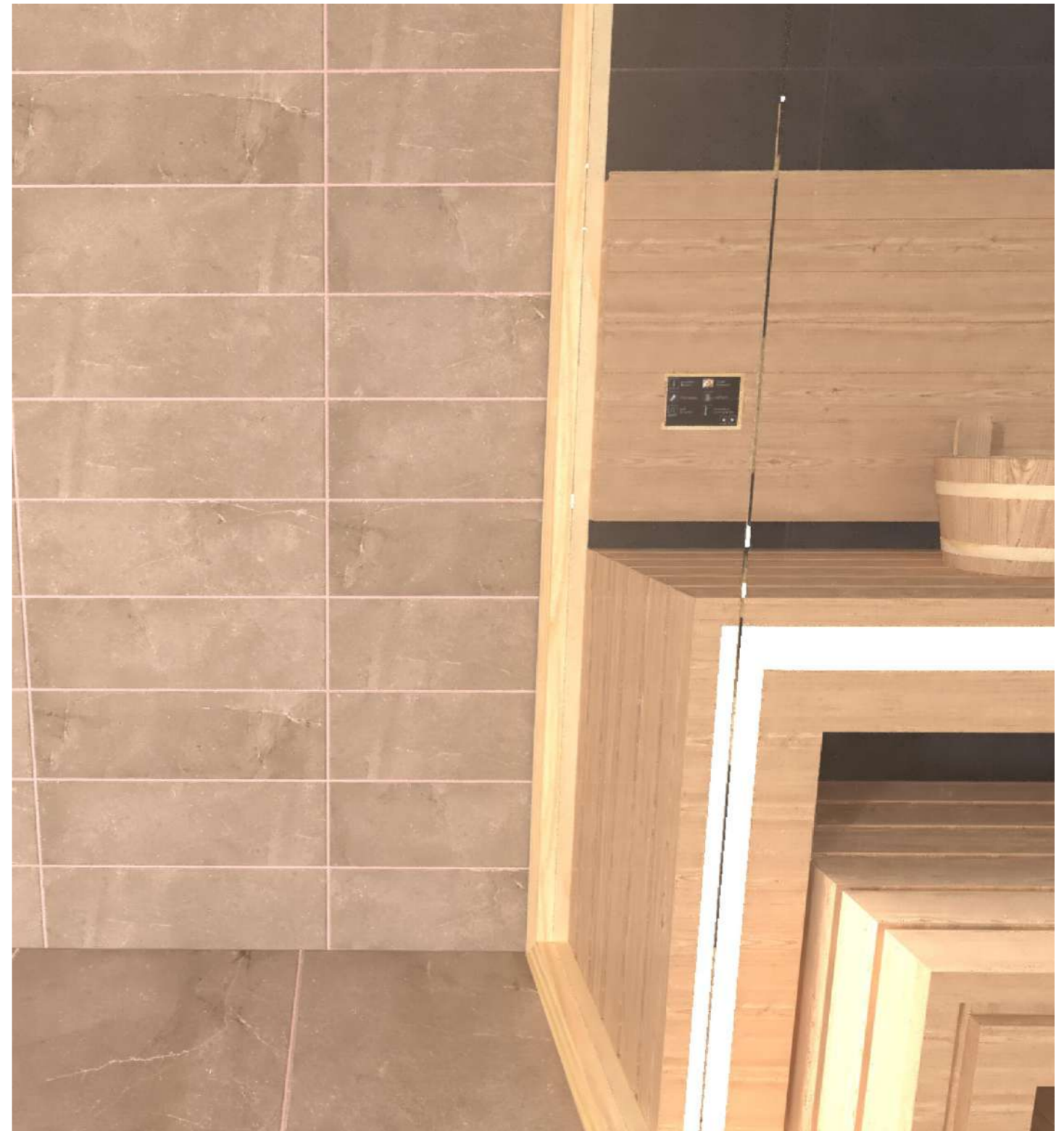

WALKS

WALKS

Grés Porcellanàto . Stoneware Porcelain . Ceràme Gres . Gres Porcelánico

Grés Porcellanàto . Stoneware Porcelain . Ceràme Gres . Gres Porcelánico

Mòsaici . Mosaics . Mosaïques . Mosàicós

Mòsaici . Mosaics . Mosaïques . Mosàicós

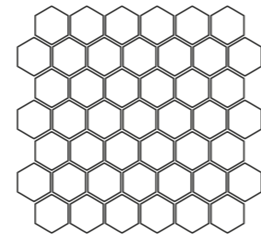
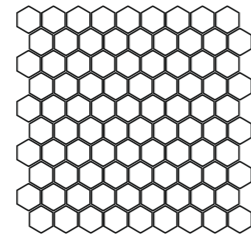
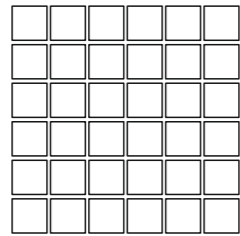
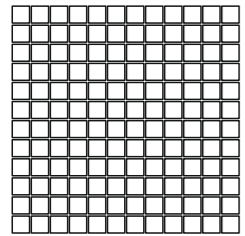

Mosaici 12
30x30
771745 Walks Sand
771746 Walks Nacar
771747 Walks Camel
771748 Walks Cemento

Mosaici 6
30x30
771749 Walks Sand
771750 Walks Nacar
771751 Walks Camel
771752 Walks Cemento

Mosaici Hex 9
29.4x29.8
771753 Walks Sand
771754 Walks Nacar
771755 Walks Camel
771756 Walks Cemento

Mosaici Hex 6
30.1x29.8
771757 Walks Sand
771758 Walks Nacar
771759 Walks Camel
771760 Walks Cemento

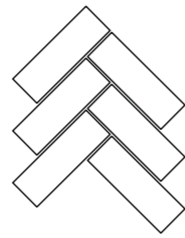
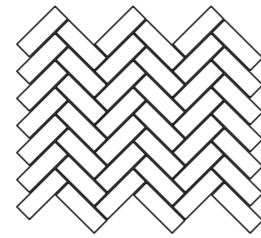
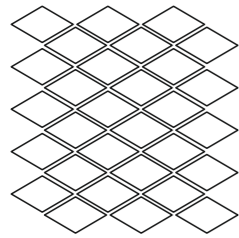
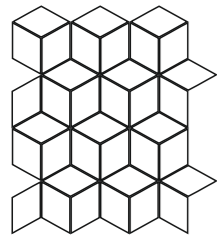

Mosaici Topaz
34.6x30
771761 Walks Sand
771762 Walks Nacar
771763 Walks Camel
771764 Walks Cemento

Mosaici Prism
29x30
771765 Walks Sand
771766 Walks Nacar
771767 Walks Camel
771768 Walks Cemento

Mosaici Herringbone 6
21.1x21.1
771769 Walks Sand
771770 Walks Nacar
771771 Walks Camel
771772 Walks Cemento

Mosaici Herringbone 2
28.3x30.5
771773 Walks Sand
771774 Walks Nacar
771775 Walks Camel
771776 Walks Cemento

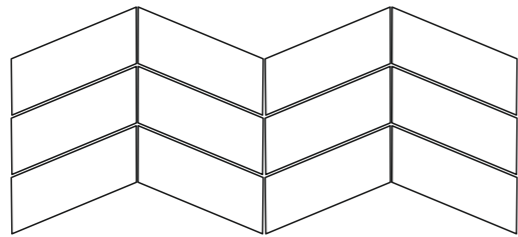
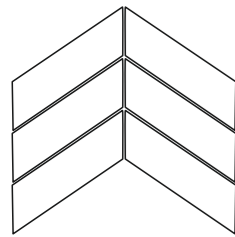

Mosaici Chevron 2
20.5x20.8
771777 Walks Sand
771778 Walks Nacar
771779 Walks Camel
771780 Walks Cemento

Mosaici Chevron 4
45.8x16.2
771781 Walks Sand Camel
771782 Walks Nacar Cemento

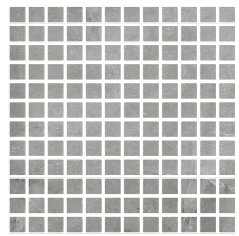
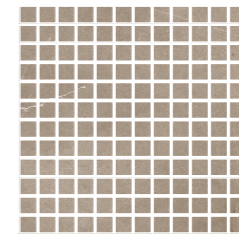
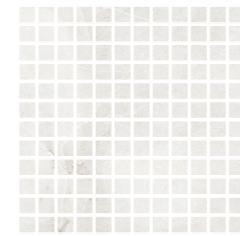
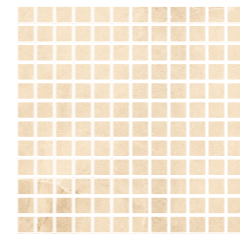

Mosaici 12
30x30
771745 Walks Sand

Mosaici 12
30x30
771746 Walks Nacar

Mosaici 12
30x30
771747 Walks Camel

Mosaici 12
30x30
771748 Walks Cemento

A990

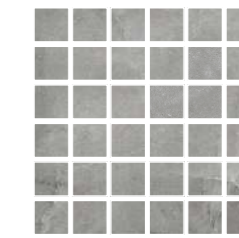
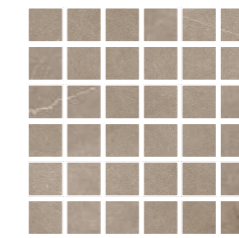
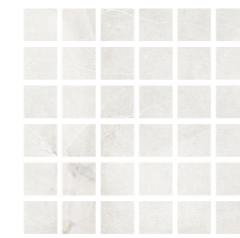
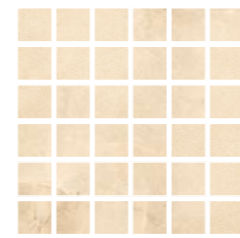

Mosaici 6
30x30
771749 Walks Sand

Mosaici 6
30x30
771750 Walks Nacar

Mosaici 6
30x30
771751 Walks Camel

Mosaici 6
30x30
771752 Walks Cemento

A990

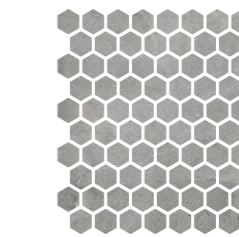
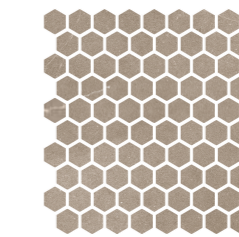
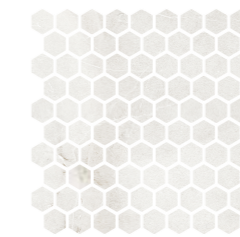
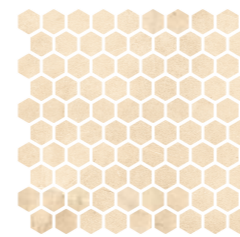

Mosaici Hex 9
29.4x29.8
771753 Walks Sand

Mosaici Hex 9
29.4x29.8
771754 Walks Nacar

Mosaici Hex 9
29.4x29.8
771755 Walks Camel

Mosaici Hex 9
29.4x29.8
771756 Walks Cemento

A991

Decorazione a base di rete. -Mesh based Decor. -Decor a base de maille. -Decoracion a base de malla



pavimento Walks Cemento 80x160

WALKS

WALKS

Grés Porcellanàto . Stoneware Porcelain . Ceràme Gres . Gres Porcelánico

Grés Porcellanàto . Stoneware Porcelain . Ceràme Gres . Gres Porcelánico

Mòsaici . Mosaics . Mosaïques . Mosàicós

Mòsaici . Mosaics . Mosaïques . Mosàicós

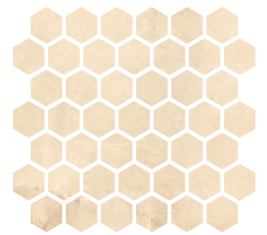

Mosaici Hex 6
30.1x29.8
771757 Walks Sand

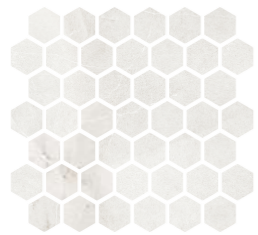

Mosaici Hex 6
30.1x29.8
771758 Walks Nacar

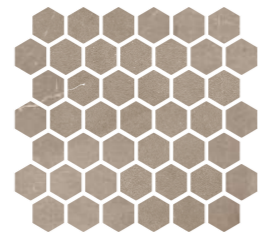

Mosaici Hex 6
30.1x29.8
771759 Walks Camel

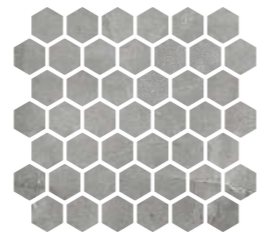

Mosaici Hex 6
30.1x29.8
771760 Walks Cemento

A991



Mosaici Herringbone 6
21.1x21.1
771769 Walks Sand

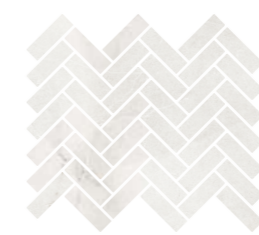

Mosaici Herringbone 6
21.1x21.1
771770 Walks Nacar

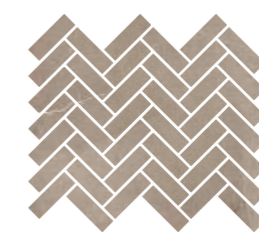

Mosaici Herringbone 6
21.1x21.1
771771 Walks Camel

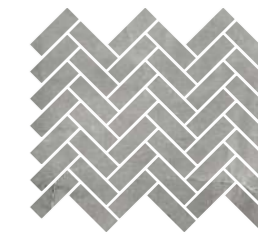

Mosaici Herringbone 6
21.1x21.1
771772 Walks Cemento

A992

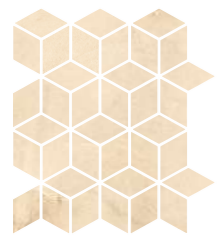

Mosaici Topaz
34.6x30
771761 Walks Sand



Mosaici Topaz
34.6x30
771762 Walks Nacar



Mosaici Topaz
34.6x30
771763 Walks Camel



Mosaici Topaz
34.6x30
771764 Walks Cemento

A992



Mosaici Herringbone 2
28.3x30.5
771773 Walks Sand



Mosaici Herringbone 2
28.3x30.5
771774 Walks Nacar



Mosaici Herringbone 2
28.3x30.5
771775 Walks Camel



Mosaici Herringbone 2
28.3x30.5
771776 Walks Cemento

A992

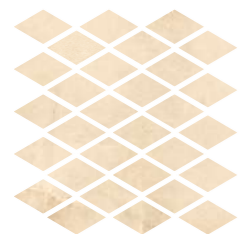

Mosaici Prism
29x30
771765 Walks Sand

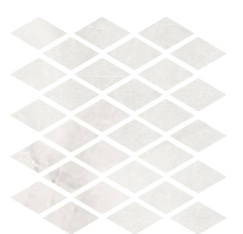

Mosaici Prism
29x30
771766 Walks Nacar

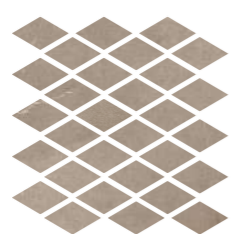

Mosaici Prism
29x30
771767 Walks Camel



Mosaici Prism
29x30
771768 Walks Cemento

A992

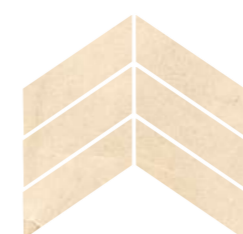

Mosaici Chevron 2
20.5x20.8
771777 Walks Sand



Mosaici Chevron 2
20.5x20.8
771778 Walks Nacar

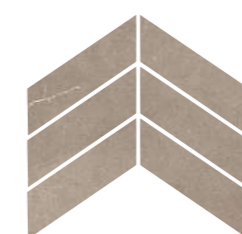

Mosaici Chevron 2
20.5x20.8
771779 Walks Camel

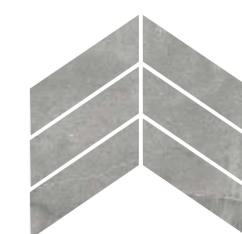

Mosaici Chevron 2
20.5x20.8
771780 Walks Cemento

A993

WALKS

WALKS

Grés Porcellanato . Stoneware Porcelain . Ceràme Gres . Gres Porcelánico

Mòsaici . Mosaics . Mosaïques . Mosàicós

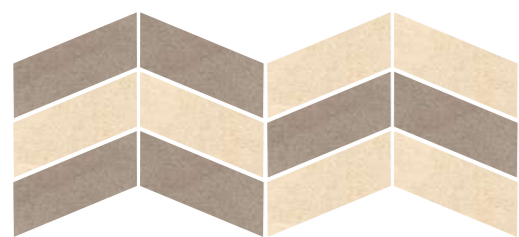

Mosaici Chevron 4
45.8x16.2
771781 Walks Sand Camel









Mosaici Chevron 4
45.8x16.2
771782 Walks Nacar Cemento

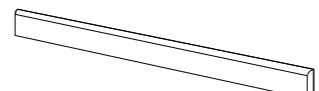

A993

Pezzi speciali . Trims . Pièces spéciales . Formstücke . Piezas especiales .

| |  BATTISCOPA |  GRADINO |  SCALINO |
|---------|---|--|--|
| | 100x1600 | 300x1600 | 200x1600 |
| | A139  | A159  | A149  |
| SAND | 771783 | 771787 | 771791 |
| NACAR | 771784 | 771788 | 771792 |
| CAMEL | 771785 | 771789 | 771793 |
| CEMENTO | 771786 | 771790 | 771794 |

Imballi . Packing . Conditionnement . Verpackungseinheiten . Embalajes .

| FORMATO SIZE FORMAT FORMATO | SPESSORE THICKNESS EPAISSEUR STÄRKE ESPESOR | KG/MQ KG/SQM KG/MC KG/QM KG/MQ | SCATOLA BOX BOÎTE KARTON CAJA КОРБОКА | | EUROPALLET | |
|--------------------------------------|---|--|---|------|------------|-------|
| | | |  | mq | box | mq |
| 80x160 . 32"x64" | 9 mm . 0,35" | 45 | 2 | 2.56 | 23 | 58.88 |
| 40x160 . 16"x64" | 9 mm . 0,35" | 45 | 4 | 2.56 | 23 | 58.88 |
| 20x160 . 8"x64" | 9 mm . 0,35" | 45 | 8 | 2.56 | 23 | 58.88 |
| 10x120 . 4"x64" | 9 mm . 0,35" | 45 | 16 | 2.56 | 23 | 58.88 |
| 80x80 . 32"x32" | 9 mm . 0,35" | 42 | 3 | 1.92 | 34 | 61.44 |
| 40x80 . 16"x32" | 9 mm . 0,35" | 42 | 6 | 1.92 | 34 | 61.44 |
| 20x80 . 8"x32" | 9 mm . 0,35" | 42 | 12 | 1.92 | 34 | 61.44 |
| 10x80 . 4"x32" | 9 mm . 0,35" | 42 | 24 | 1.92 | 34 | 61.44 |
| 70x80 . 28"x32" | 9 mm . 0,35" | 42 | 3 | 1.92 | 34 | 61.44 |
| 30x30 . 12"x12" | 9 mm . 0,35" | 30 | 10 | - | - | - |

CARATTERISTICHE TECNICHE

Technical specifications | Technische Eigenschaften | Caractéristiques techniques | Características técnicas |

STANDARD EN 14411 - G

| | CARATTERISTICHE TECNICHE TECHNICAL DATA TECHNISCHE DATEN CARACTERISTIQUES TECHNIQUES | NORMA STANDARD NORM NORME | VALORI PRESCRITTI DALLE NORME EN 14411 - G INTERNATIONAL STANDARDS EN 14411 - G INTERNATIONALE NORMWERTE EN 14411 - G VALEURS PREVUES PAR LES NORMES EN 14411 - G | VALORE MEDIO CERAGRES CERAGRES AVERAGE VALUE CERAGRES MITTELWERT VALEURS MOYEN CERAGRES |
|--|---|------------------------------------|--|--|
| | CARATTERISTICHE DIMENSIONALI - SIZE CHARACTERISTICS - MASSEIGENSCHAFTEN DETERMINATION DES CARACTERISTIQUES DIMENSIONNELLES - CARACTERÍSTICAS DIMENSIONALES - РАЗМЕРНЫЕ ХАРАКТЕРИСТИКИ - 尺寸特征 | | | NAT (UGL) |
| | LATI SIDES - SEITEN COTES - CANTOS РАЗМЕРЫ СТОРОН - 側邊 | EN ISO 10545-2 | ± 0,3% MAX (± 1,0 mm MAX) | CONFORME COMPLYING |
| | SPESORE THICKNESS - DICKE EPAISSEUR - ESPESOR ТОЛЩИНА - 厚度 | EN ISO 10545-2 | ± 5,0% MAX (± 0,5 mm MAX) | CONFORME COMPLYING |
| | RETTILINEITÀ DEGLI SPIGOLI STRAIGHTNESS OF SIDES - GERADLINIGKEIT DER KANTEN RECTITUDE DES ARETES - RECTITUD DE LOS CANTOS КОСОУГОЛЬНОСТЬ - 边角平直度 | EN ISO 10545-2 | ± 0,3% MAX (± 0,8 mm MAX) | CONFORME COMPLYING |
| | ORTOGONALITÀ RECTANGULARITY - RECHTWINKLIGKEIT PERPENDICULARITÉ - ORTOGONALIDAD КРИВИЗНА СТОРОН - 直角度 | EN ISO 10545-2 | ± 0,3% MAX (± 1,5 mm MAX) | CONFORME COMPLYING |
| | PLANARITÀ SURFACE FLATNESS - EBENFLÄCHIGKEIT PLANEITE DE SURFACE - PLANEIDAD КРИВИЗНА ЛИЦЕВОЙ ПОВЕРХНОСТИ - 平整度 | EN ISO 10545-2 | ± 0,4% MAX (± 1,8 mm MAX) | CONFORME COMPLYING |
| | ASSORBIMENTO D'ACQUA WATER ABSORPTION - WASSERAUFNAHME ABSORPTION D'EAU - ABSORCIÓN DE AGUA ВОДОПОГЛОЩЕНИЕ - 吸水率 | EN ISO 10545-3 | ≤ 0,5% | ≤ 0,1% |
| | RESISTENZA ALLA FLESSIONE FLEXION RESISTANCE - BIEGEFESTIGKEIT RESISTANCE A LA FLEXION - RESISTENCIA A LA FLEXIÓN ПРЕДЕЛ ПРОЧНОСТИ ПРИ ИЗГИБЕ - 抗弯强度 | EN ISO 10545-4 | S ≥ 700 N (< 7,5 mm) S ≥ 1.300 N (> 7,5 mm) R ≥ 35 N/mm². | S ≥ 2.800 N R ≥ 49 N/mm² (formato 600x600 24"x24" size) |
| | RESISTENZA ALL'URTO IMPACT RESISTANCE - STOSSFESTIGKEIT RESISTANCE AUX CHOCES - RESISTENCIA A LOS GOLPES УДАРСТОЙКОСТЬ - 抗冲击强度 | EN ISO 10545-5 | VALORE DICHIARATO DECLARED VALUE | > 0,80 |
| | RESISTENZA ALL'ABRASIONE ABRASION RESISTANCE - ABRIEFESTIGKEIT RESISTANCE A L'ABRASION - RESISTENCIA A LA ABRASIÓN СТОЙКОСТЬ К ИСТИРАНИЮ - 耐磨强度 | EN ISO 10545-6 | ≤ 175 mm³ | < 150 mm³ |
| | COEFFICIENTE DI DILATAZIONE TERMICA LINEARE COEFFICIENT OF LINEAR THERMAL-EXPANSION - LINEARER WÄRMEAUDEHNUNGSKOEFFIZIENT COEFFICIENT DE DILATATION THERMIQUE LINEAIRE - COEFICIENTE DE DILATACIÓN TÉRMICA LINEAL КОЭФФИЦИЕНТ ЛИНЕЙНОГО ТЕРМИЧЕСКОГО РАСШИРЕНИЯ - 线性热膨胀系数 | EN ISO 10545-8 | - | α=7,3x10 ⁻⁶ °C ⁻¹ |
| | RESISTENZA AGLI SBALZI TERMICI RESISTANCE TO THERMAL SHOCKS - BESTÄNDIGKEIT GEGEN TEMPERATURSCHWANKUNGEN RESISTANCE AUX CHOCES THERMIQUES - RESISTENCIA A LOS CHOQUES TÉRMICOS СТОЙКОСТЬ К ПЕРЕПАДАМ ТЕМПЕРАТУРЫ - 耐热突变性 | EN ISO 10545-9 | TEST SUPERATO SECONDO EN ISO 10545-1 PASS ACCORDING EN ISO 10545-1 | NESSUN DANNO NO DAMAGE |
| | RESISTENZA AL GELO FROST RESISTANCE - FROSTBESTÄNDIGKEIT RESISTANCE AU GEL - RESISTENCIA AL HIELO МОРОЗОСТОЙКОСТЬ - 耐冻性 | EN ISO 10545-12 | TEST SUPERATO SECONDO EN ISO 10545-1 PASS ACCORDING EN ISO 10545-1 | NESSUN DANNO NO DAMAGE |
| | RESISTENZA ALL'ATTACCO CHIMICO RESISTANCE TO CHEMICALS - CHEMIKALIENBESTÄNDIGKEIT RESISTANCE A L'ATTAQUE CHIMIQUE - RESISTENCIA QUÍMICA ХИМИЧЕСКАЯ СТОЙКОСТЬ - 耐化学品作用 | EN ISO 10545-13 | UB MIN. | UA ULA UHA |
| | RESISTENZA ALLE MACCHIE RESISTANCE TO STAINS - FLECKENBESTÄNDIGKEIT RESISTANCE AUX TACHES - RESISTENCIA A LAS MANCHAS УСТОЙЧИВОСТЬ К ПЯТНООБРАЗОВАНИЮ - 防污性 | EN ISO 10545-14 | VALORE DICHIARATO DECLARED VALUE | 5 |
| | CESSIONE DI PIOMBO E CADMIO LEAD AND CADMIUM DISCHARGE - ABGABE VON BLEI UND CADMIUM PERTÉ DE PLOMB ET CADMIUM - CESIÓN DE PLOMO Y CADMIO ВЫДЕЛЕНИЕ СВИНЦА И КАДМИЯ - 铅和镉的排放 | EN ISO 10545-15 | VALORE DICHIARATO DECLARED VALUE | < AL LIMITE DI RILEVAMENTO < THAN INSTRUMENT LIMIT |
| | | | | NAT |
| | | DM. 236/89 BCRA | > 0,40 | > 0,40 |
| | | ASTM C1028 | SCOF > 0,60 | > 0,60 |
| | | ANSI A137.1 | Wet DCOF > 0,42 | > 0,42 |
| | | AS 4586:2013 | - | - |
| | | DIN 51130 | - | R9 |
| | | DIN 51097 | - | - |
| | | ENV 12633 | ≥ CL1 | CL1 |
| | | BS 7976 | ≥ 36 | ≥ 36 |
| | SCIVOLOSITÀ SKID RESISTANCE - RUTSCHWERT GLISSANCE - ADHERENCIA | | | |



CÉRAGRÈS
LUXE

touch@ceragresceramics.com
www.ceragresceramics.com