

**CERAGRÉS**  
LUXE

---

**ALWAYS**



LUXE



**ALWAYS**



**ALWAYS**

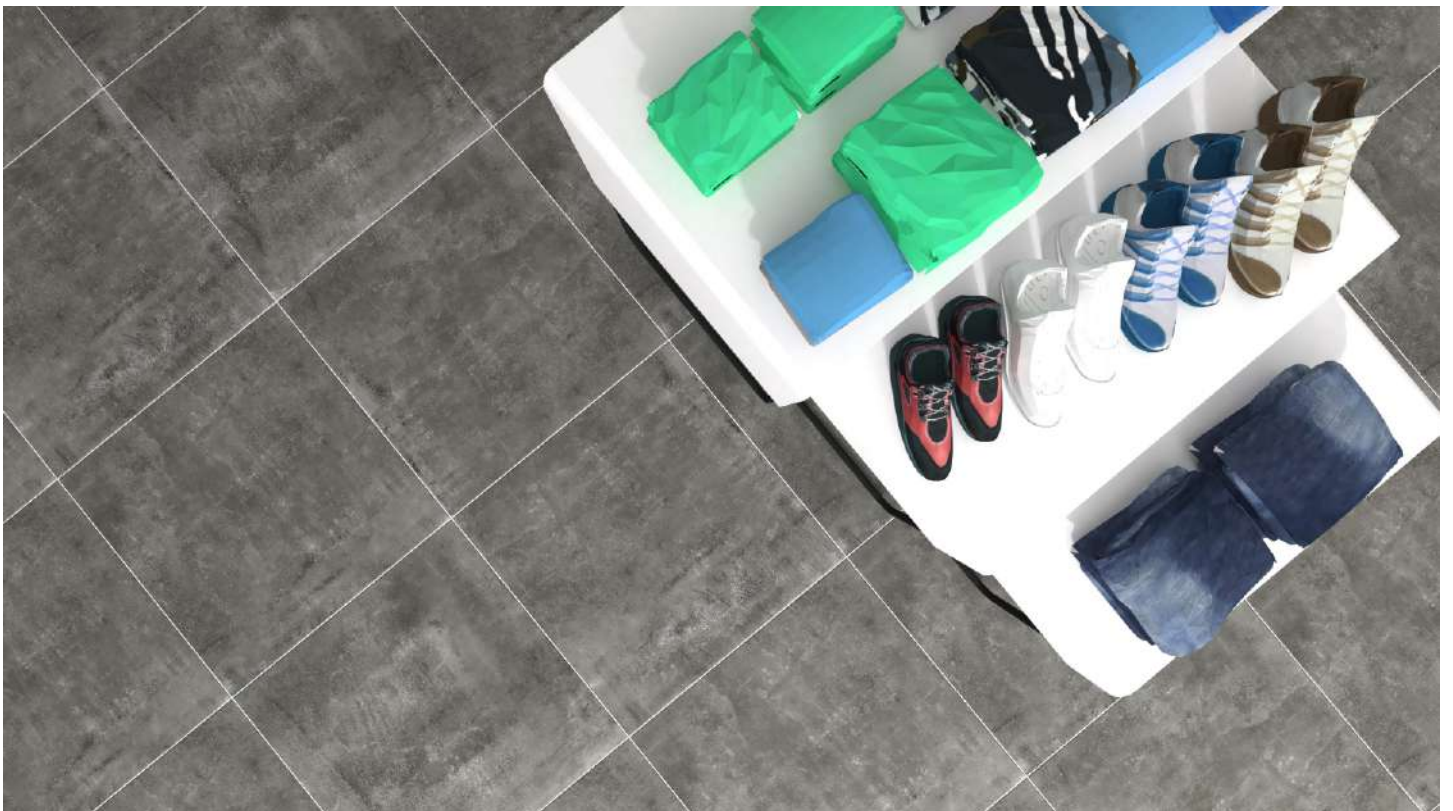

Always Negro 800x800



**ALWAYS**

**Colori . Colours . Couleurs . Colores**



Marfil



Blanco



Moka



Negro

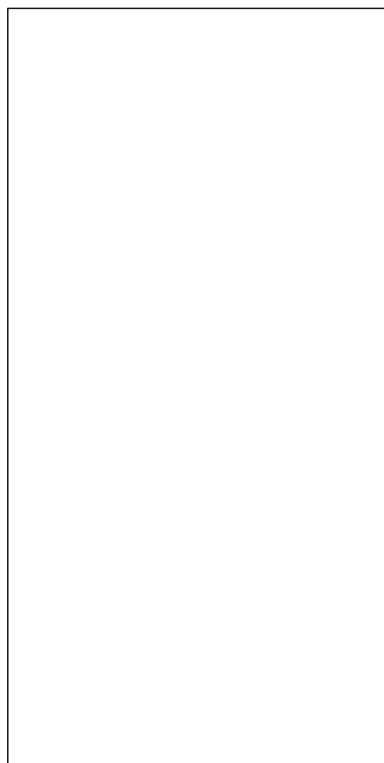

80x160 R  
32"x64"  
770701 Always Marfil  
770702 Always Bianco  
770703 Always Moka  
770704 Always Negro

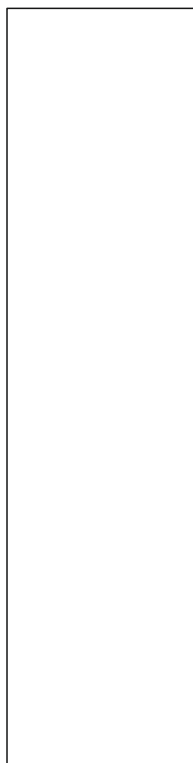

40x160 R  
16"x64"  
770705 Always Marfil  
770706 Always Bianco  
770707 Always Moka  
770708 Always Negro



A95

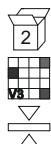

20x160 R  
8"x64"  
770709 Always Marfil  
770710 Always Bianco  
770711 Always Moka  
770712 Always Negro

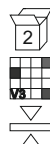

10x160 R  
4"x64"  
770713 Always Marfil  
770714 Always Bianco  
770715 Always Moka  
770716 Always Negro



A95



## Formati . Sizes . Formats . Formatos



80x80 R  
32"x32"  
770717 Always Marfil  
770718 Always Blanco  
770719 Always Moka  
770720 Always Negro



A95

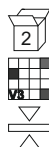

40x80 R  
16"x32"  
770721 Always Marfil  
770722 Always Blanco  
770723 Always Moka  
770724 Always Negro



A95



20x80 R  
8"x32"  
770725 Always Marfil  
770726 Always Blanco  
770727 Always Moka  
770728 Always Negro



A95

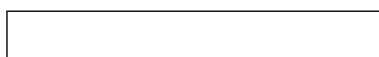

10x80 R  
4"x32"  
770729 Always Marfil  
770730 Always Blanco  
770731 Always Moka  
770732 Always Negro



A95

## Formati . Sizes . Formats . Formatos

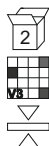
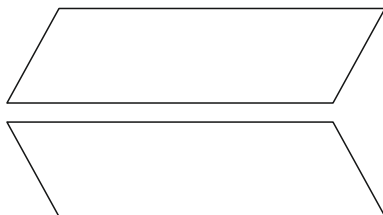

20x80 R  
8"x32"



770733 Always Marfil L  
770734 Always Marfil R  
770735 Always Bianco L  
770736 Always Bianco R  
770737 Always Moka L  
770738 Always Moka R  
770737 Always Negro L  
770738 Always Negro R

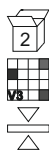
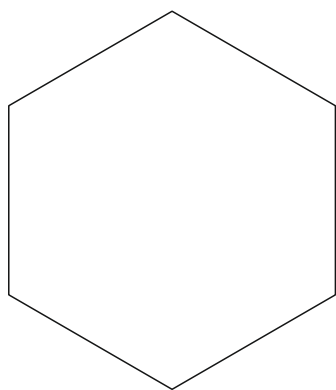

70x80 R  
28"x32"



770739 Always Marfil  
770740 Always Bianco  
770741 Always Moka  
770742 Always Negro





ALWAYS



**ALWAYS**



800x800



100x800



200x800



400x800



800x1600



400x1600



200x1600



100x1600

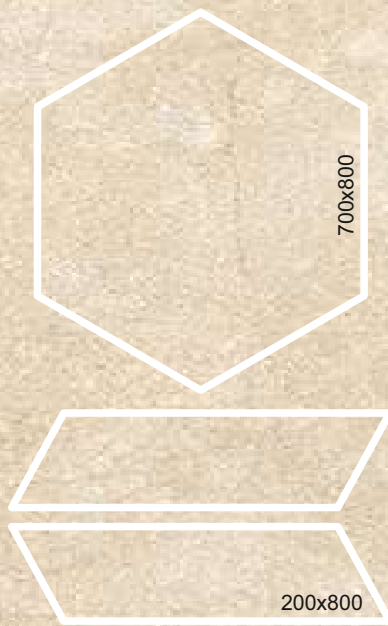

700x800

200x800



Formati . Sizes . Formats . Formatos



80x160 R  
32"x64"  
770701 Always Marfil



40x160 R  
16"x64"  
770705 Always Marfil



A95

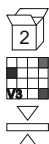

20x160 R  
8"x64"  
770709 Always Marfil

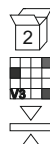

10x160 R  
4"x64"  
770713 Always Marfil



A95

Formati . Sizes . Formats . Formatos



80x80 R  
32"x32"  
770717 Always Marfil



A95



40x80 R  
16"x32"  
770721 Always Marfil



A95



20x80 R  
8"x32"  
770725 Always Marfil



A95



10x80 R  
4"x32"  
770729 Always Marfil



A95

Formati . Sizes . Formats . Formatos



20x80 R  
8"x32"  
770733 Always Marfi L  
770734 Always Marfi R



A95

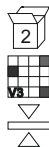

70x80 R  
28"x32"  
770739 Always Marfi



A95

ALWAYS

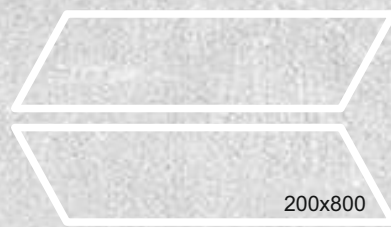
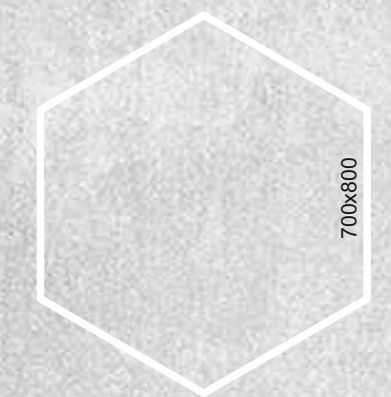
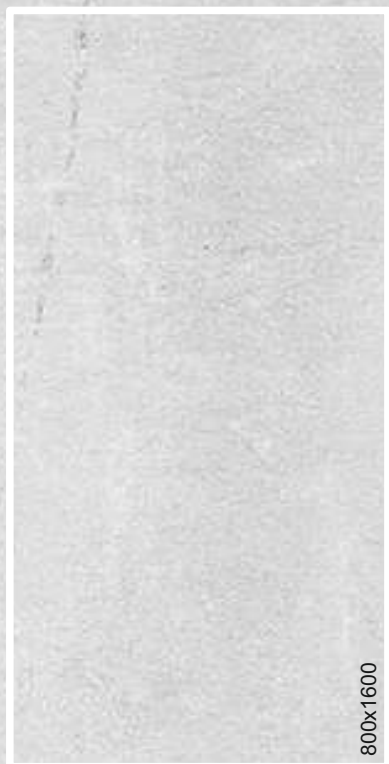
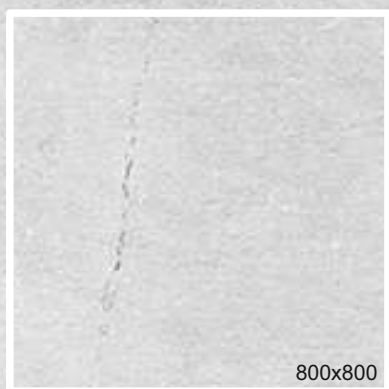

Formati . Sizes . Formats . Formatos

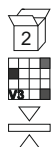

80x160 R  
32"x64"  
770701 Always Marfil

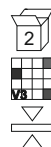

40x160 R  
16"x64"  
770705 Always Marfil



A95



20x160 R  
8"x64"  
770709 Always Marfil

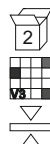

10x160 R  
4"x64"  
770713 Always Marfil



A95



Formati . Sizes . Formats . Formatos



80x80 R  
32"x32"  
770718 Always Blanco



A95

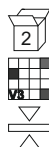

40x80 R  
16"x32"  
770722 Always Blanco



A95

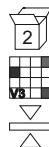

20x80 R  
8"x32"  
770726 Always Blanco



A95



10x80 R  
4"x32"  
770730 Always Blanco



A95

## Formati . Sizes . Formats . Formatos

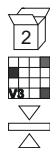

20x80 R  
8"x32"  
770735 Always Blanco L  
770736 Always Blanco R

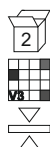

70x80 R  
28"x32"  
770740 Always Blanco





pavimento Always Blanco 800x800

ALWAYS

TOM  
FORD

*Rizzoli*

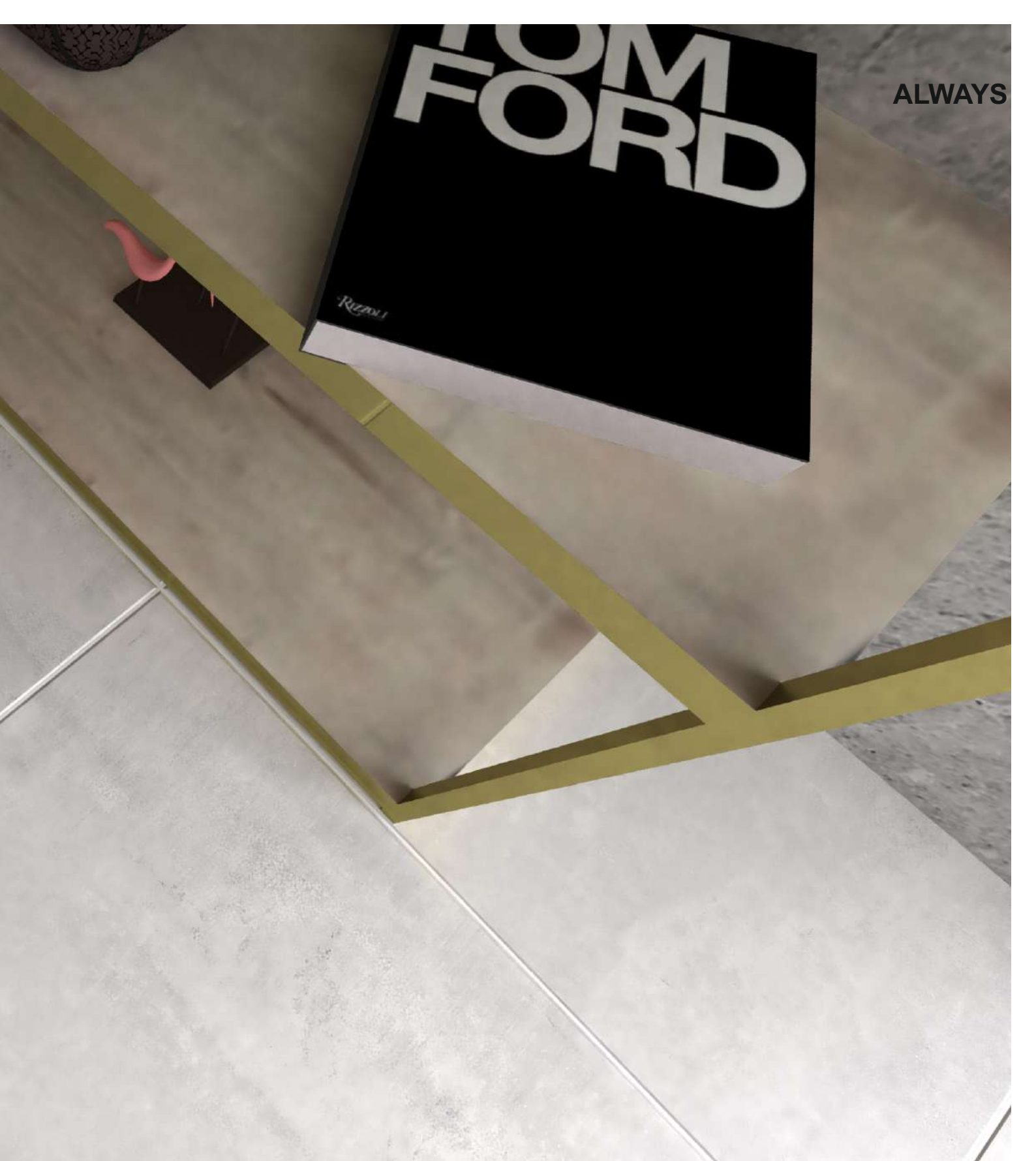



ALWAYS

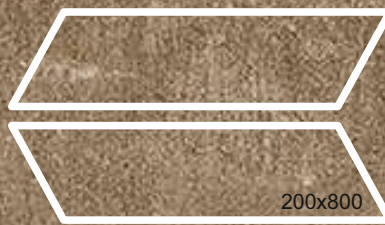
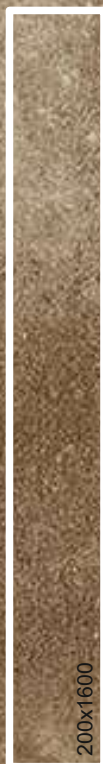



Formati . Sizes . Formats . Formatos



80x160 R  
32"x64"  
770703 Always Moka



40x160 R  
16"x64"  
770707 Always Moka



A95

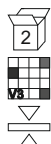

20x160 R  
8"x64"  
770711 Always Moka

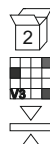

10x160 R  
4"x64"  
770715 Always Moka



A95

Formati . Sizes . Formats . Formatos



80x80 R  
32"x32"  
770719 Always Moka



A95

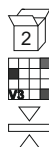

40x80 R  
16"x32"  
770723 Always Moka



A95



20x80 R  
8"x32"  
770727 Always Moka



A95



10x80 R  
4"x32"  
770731 Always Moka



A95

## Formati . Sizes . Formats . Formatos

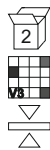

20x80 R  
8"x32"  
770737 Always Moka L  
770738 Always Moka R

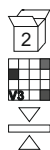

70x80 R  
28"x32"  
770739 Always Marfil  
770740 Always Bianco  
770741 Always Moka  
770742 Always Negro





ALWAYS

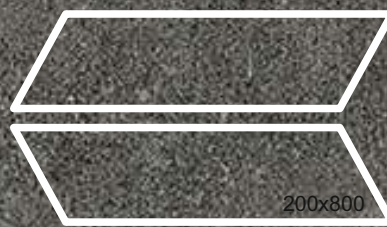
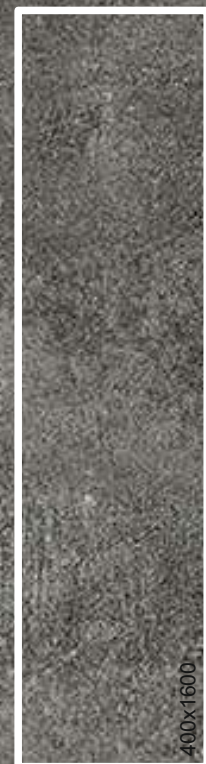
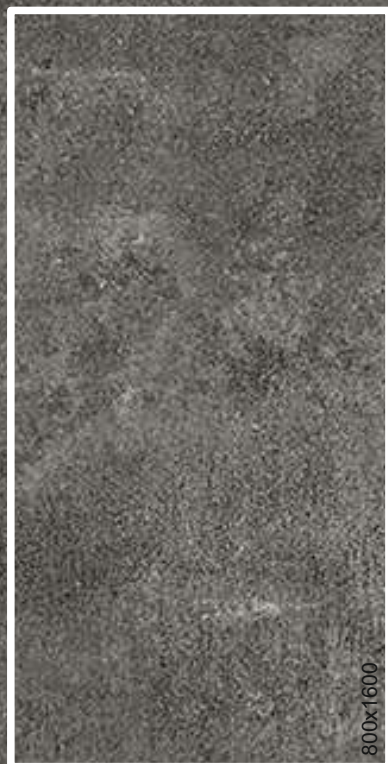
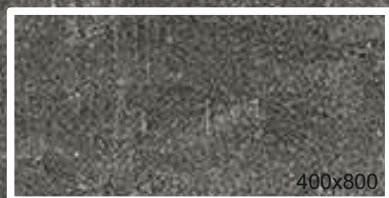
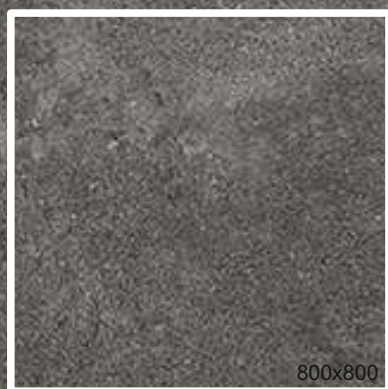



Formati . Sizes . Formats . Formatos



80x160 R  
32"x64"  
770704 Always Negro



40x160 R  
16"x64"  
770708 Always Negro



A95

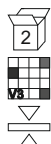

20x160 R  
8"x64"  
770712 Always Negro

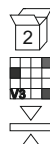

10x160 R  
4"x64"  
770716 Always Negro



A95

Formati . Sizes . Formats . Formatos



80x80 R  
32"x32"  
770720 Always Negro



A95

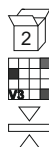

40x80 R  
16"x32"  
770724 Always Negro



A95



20x80 R  
8"x32"  
770728 Always Negro



A95



10x80 R  
4"x32"  
770732 Always Negro



A95

## Formati . Sizes . Formats . Formatos

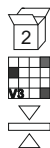

20x80 R  
8"x32"  
770737 Always Negro L  
770738 Always Negro R

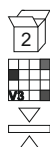

70x80 R  
28"x32"  
770742 Always Negro



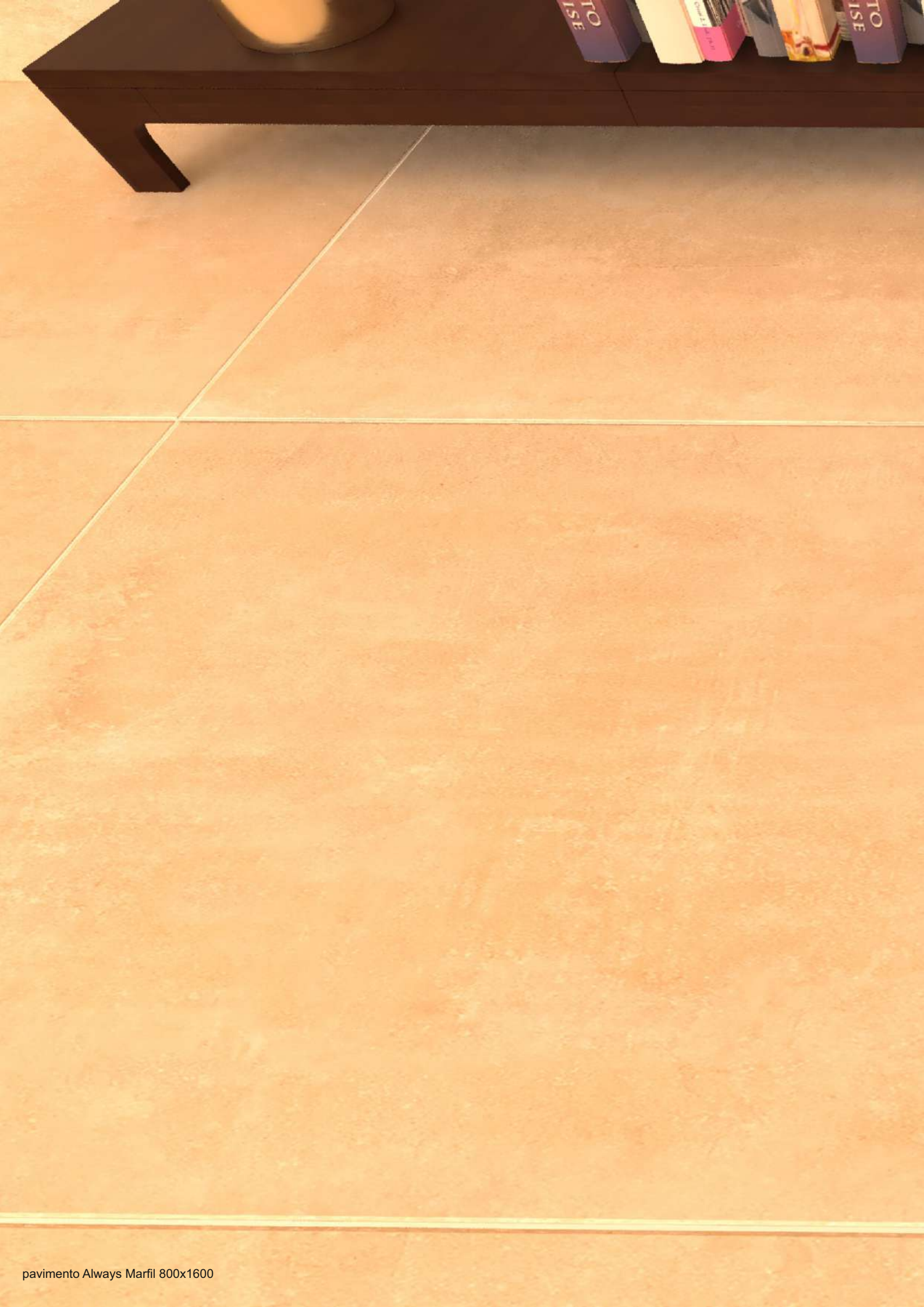



**ALWAYS**



## Grés Porcellanàto . Stoneware Porcelain . Ceràmè Gres . Gres Porcèlanico

### Mòsaici . Mosaics . Mosaïques . Mosàicós

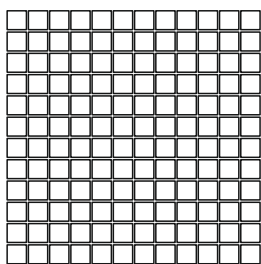

**Mosaici 12**  
30x30  
770743 Always Marfil  
770744 Always Blanco  
770745 Always Moka  
770746 Always Negro

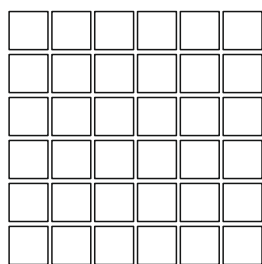

**Mosaici 6**  
30x30  
770747 Always Marfil  
770748 Always Blanco  
770749 Always Moka  
770750 Always Negro

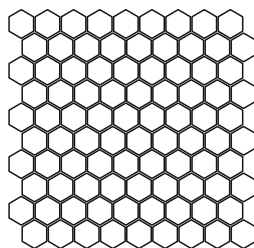

**Mosaici Hex 9**  
30x30  
770751 Always Marfil  
770752 Always Blanco  
770753 Always Moka  
770754 Always Negro

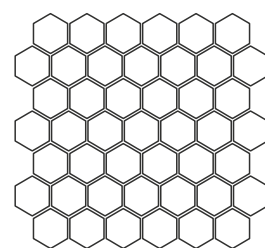

**Mosaici Hex 6**  
30x30  
770755 Always Marfil  
770756 Always Blanco  
770757 Always Moka  
770758 Always Negro

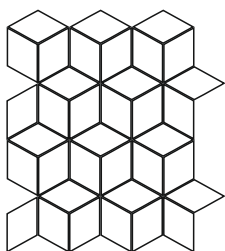

**Mosaici Topaz**  
30x30  
770759 Always Marfil  
770760 Always Blanco  
770761 Always Moka  
770762 Always Negro

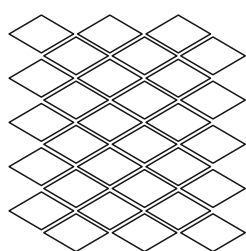

**Mosaici Prism**  
30x30  
770763 Always Marfil  
770764 Always Blanco  
770765 Always Moka  
770766 Always Negro

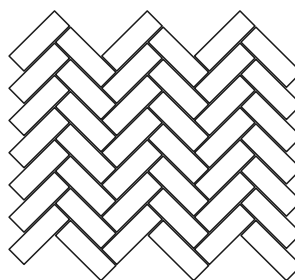

**Mosaici Herringbone 6**  
30x30  
770767 Always Marfil  
770768 Always Blanco  
770769 Always Moka  
770770 Always Negro

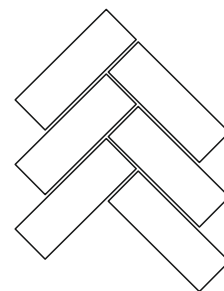

**Mosaici Herringbone 2**  
30x30  
770771 Always Marfil  
770772 Always Blanco  
770773 Always Moka  
770774 Always Negro

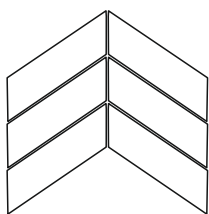

**Mosaici Chevron 2**  
30x30  
770775 Always Marfil  
770776 Always Blanco  
770777 Always Moka  
770778 Always Negro

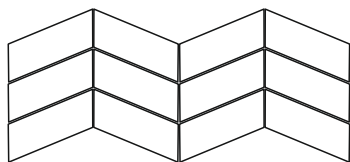

**Mosaici Chevron 4**  
30x30  
770779 Always Marfil  
770780 Always Blanco  
770781 Always Moka  
770782 Always Negro

## Grés Porcellanàto . Stoneware Porcelain . Ceràme Gres . Gres Porcèlanico

### Mòsaici . Mosaics . Mosaïques . Mosàicós

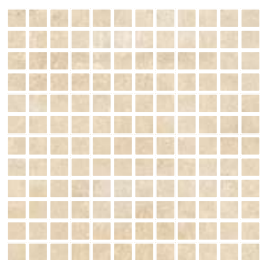

Mosaici 12  
30x30  
770743 Always Marfil

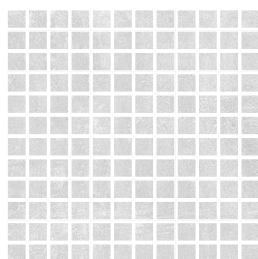

Mosaici 12  
30x30  
770744 Always Blanco

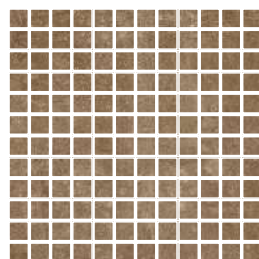

Mosaici 12  
30x30  
770745 Always Moka

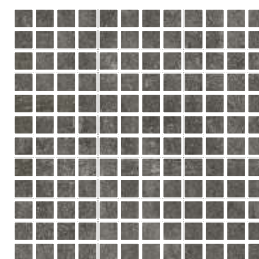

Mosaici 12  
30x30  
770746 Always Negro

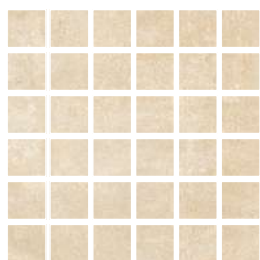

Mosaici 6  
30x30  
770747 Always Marfil

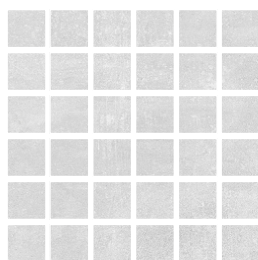

Mosaici 6  
30x30  
770748 Always Blanco

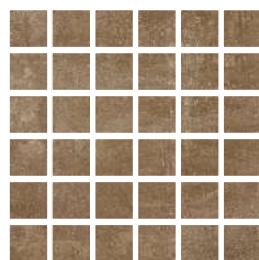

Mosaici 6  
30x30  
770749 Always Moka

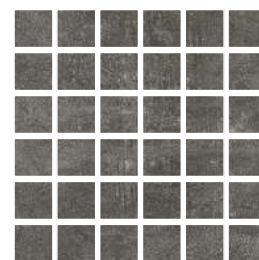

Mosaici 6  
30x30  
770750 Always Negro

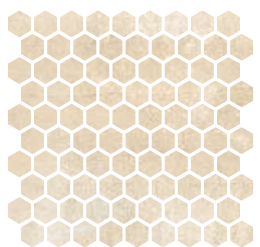

Mosaici Hex 9  
30x30  
770751 Always Marfil

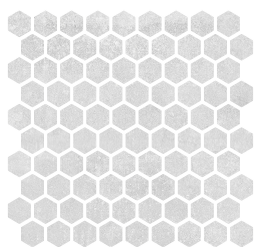

Mosaici Hex 9  
30x30  
770752 Always Blanco

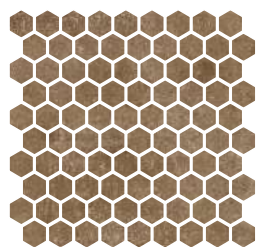

Mosaici Hex 9  
30x30  
770753 Always Moka

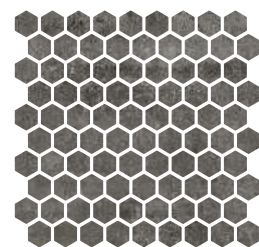

Mosaici Hex 9  
30x30  
770754 Always Negro

## Grés Porcellanàto . Stoneware Porcelain . Ceràme Gres . Gres Porcelánico

### Mòsaici . Mosaics . Mosaïques . Mosàicós

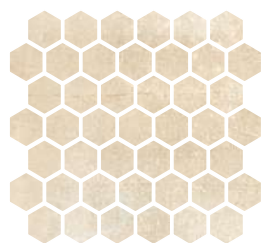

Mosaici Hex 6  
30x30  
770755 Always Marfil

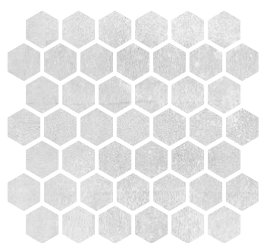

Mosaici Hex 6  
30x30  
770756 Always Blanco

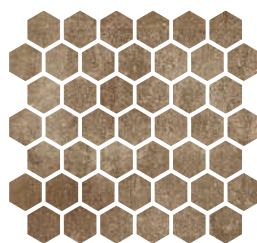

Mosaici Hex 6  
30x30  
770757 Always Moka



Mosaici Hex 6  
30x30  
770758 Always Negro

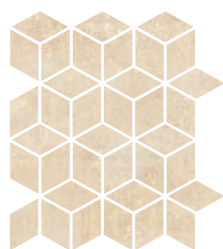

Mosaici Topaz  
30x30  
770759 Always Marfil

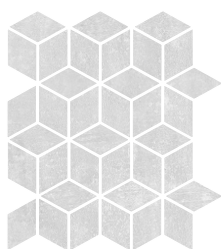

Mosaici Topaz  
30x30  
770760 Always Blanco



Mosaici Topaz  
30x30  
770761 Always Moka

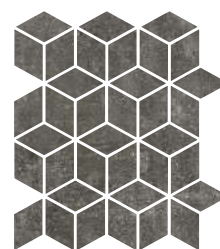

Mosaici Topaz  
30x30  
770762 Always Negro

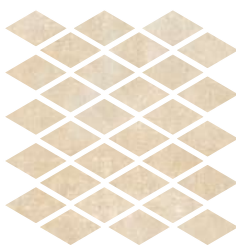

Mosaici Prism  
30x30  
770763 Always Marfil

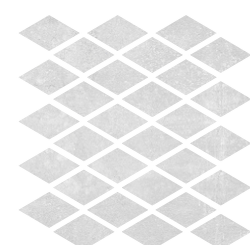

Mosaici Prism  
30x30  
770764 Always Blanco

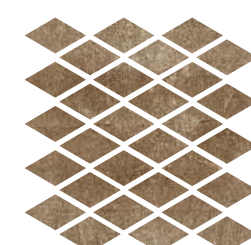

Mosaici Prism  
30x30  
770765 Always Moka

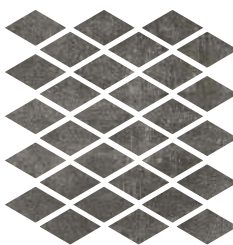

Mosaici Prism  
30x30  
770766 Always Negro



Grés Porcellanàto . Stoneware Porcelain . Ceràme Gres . Gres Porcelànico

Mòsaici . Mosaics . Mosaiques . Mosàicós



Mosaici Herringbone 6  
30x30  
770767 Always Marfil

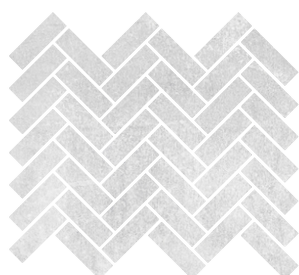

Mosaici Herringbone 6  
30x30  
770768 Always Blanco



Mosaici Herringbone 6  
30x30  
770769 Always Moka



Mosaici Herringbone 6  
30x30  
770770 Always Negro

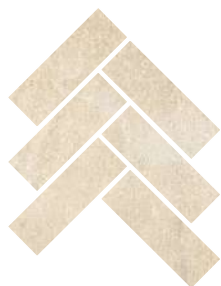

Mosaici Herringbone 2  
30x30  
770771 Always Marfil

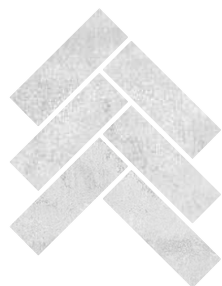

Mosaici Herringbone 2  
30x30  
770772 Always Blanco



Mosaici Herringbone 2  
30x30  
770773 Always Moka



Mosaici Herringbone 2  
30x30  
770774 Always Negro

Grés Porcellanàto . Stoneware Porcelain . Ceràme Gres . Gres Porcèlanico

Mòsaici . Mosaics . Mosaïques . Mosàicós



Mosaici Chevron 2  
30x30  
770775 Always Marfil

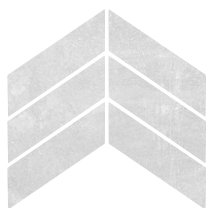

Mosaici Chevron 2  
30x30  
770776 Always Blanco



Mosaici Chevron 2  
30x30  
770777 Always Moka

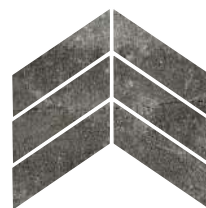

Mosaici Chevron 2  
30x30  
770778 Always Negro



Mosaici Chevron 4  
30x30  
770779 Always Marfil Moka

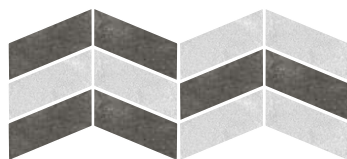

Mosaici Chevron 4  
30x30  
770780 Always Blanco Negro









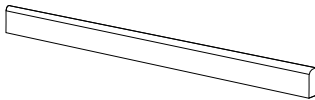

**ALWAYS**







## Pezzi speciali . Trims . Pièces spéciales . Formstücke . Piezas especiales .

	 <b>BATTISCOPA</b> 100x1600  	 <b>GRADINO</b> 300x1600  	 <b>SCALINO</b> 200x1600  
MARFIL	770781	770785	770789
BIANCO	770782	770786	770790
MOKA	770783	770787	770791
NEGRO	770784	770788	770792

## Imballi . Packing . Conditionnement . Verpackungseinheiten . Embalajes .

FORMATO SIZE FORMAT FORMAT FORMATO	SPESSORE THICKNESS EPAISSEUR STÄRKE ESPESOR	KG/MQ KG/SQM KG/MC KG/QM KG/MQ	SCATOLA		EUROPALLET	
			BOX	BOÎTE	KARTON	CAJA
				mq	box	mq
<b>80x160</b> . 32"x64"	9 mm . 0,35"	30	2	1.43	32	45.82
<b>80x80</b> . 32"x32"	9 mm . 0,35"	30	4	1.43	40	57.20
<b>40x160</b> . 16"x64"	9 mm . 0,35"	30	4	1.43	-	-
<b>40x80</b> . 16"x32"	9 mm . 0,35"	19	5	0.92	-	-
<b>20x160</b> . 8"x64"	9 mm . 0,35"	30	6	1.43	-	-
<b>20x80</b> . 8"x32"	9 mm . 0,35"	34	10	1.11	-	-
<b>30x30</b> . 12"x12"	9 mm . 0,35"	34	10	1.11	-	-

# CARATTERISTICHE TECNICHE

Technical specifications | Technische Eigenschaften | Caractéristiques techniques | Características técnicas |

## STANDARD EN 14411 - G

CARATTERISTICHE TECNICHE TECHNICAL DATA TECHNISCHE DATEN CARACTERISTIQUES TECHNIQUES	NORMA STANDARD NORM NORME	VALORI PRESCRITTI DALLE NORME EN 14411 - G INTERNATIONAL STANDARDS EN 14411 - G INTERNATIONALE NORMWERTE EN 14411 - G VALEURS PREVUES PAR LES NORMES EN 14411 - G	VALORE MEDIO CERAGRES CERAGRES AVERAGE VALUE CERAGRES MITTELWERT VALEURS MOYEN CERAGRES
<b>CARATTERISTICHE DIMENSIONALI</b> - SIZE CHARACTERISTICS - MASSEIGENSCHAFTEN DETERMINATION DES CARACTERISTIQUES DIMENSIONELLES - CARACTERÍSTICAS DIMENSIONALES - РАЗМЕРНЫЕ ХАРАКТЕРИСТИКИ - 尺寸特征			<b>NAT (UGL)</b>
<b>LATI</b> SIDES - SEITEN COTES - CANTOS РАЗМЕРЫ СТОРОН - 側邊	EN ISO 10545-2	± 0,3% MAX (± 1,0 mm MAX)	CONFORME COMPLYING
<b>SPESSORE</b> THICKNESS - DICKE ÉPAISSEUR - ESPESOR ТОЛЩИНА - 厚度	EN ISO 10545-2	± 5,0% MAX (± 0,5 mm MAX)	CONFORME COMPLYING
<b>RETTILINEITÀ DEGLI SPIGOLI</b> STRAIGHTNESS OF SIDES - GERADLINIGKEIT DER KANTEN RECTITUDE DES ARETES - RECTIDUD DE LOS CANTOS КОСОУГОЛЬНОСТЬ - 边角平直度	EN ISO 10545-2	± 0,3% MAX (± 0,8 mm MAX)	CONFORME COMPLYING
<b>ORTOGONALITÀ</b> RECTANGULARITY - RECHTWINKLIGKEIT PERPENDICULARITÉ - ORTOGONALIDAD КРИВИЗНА СТОРОН - 直角度	EN ISO 10545-2	± 0,3% MAX (± 1,5 mm MAX)	CONFORME COMPLYING
<b>PLANARITÀ</b> SURFACE FLATNESS - EBENFLÄCHIGKEIT PLANEITE DE SURFACE - PLANEIDAD КРИВИЗНА ЛИЦЕВОЙ ПОВЕРХНОСТИ - 平整度	EN ISO 10545-2	± 0,4% MAX (± 1,8 mm MAX)	CONFORME COMPLYING
<b>ASSORBIMENTO D'ACQUA</b> WATER ABSORPTION - WASSERAUFNAHME ABSORPTION D'EAU - ABSORCIÓN DE AGUA ВОДОПОГЛОЩЕНИЕ - 吸水率	EN ISO 10545-3	≤ 0,5%	≤ 0,1%
<b>RESISTENZA ALLA FLESSIONE</b> FLEXION RESISTANCE - BIEGEFESTIGKEIT RESISTANCE A LA FLEXION - RESISTENCIA A LA FLEXIÓN ПРЕДЕЛ ПРОЧНОСТИ ПРИ ИЗГИБЕ - 抗弯强度	EN ISO 10545-4	S ≥ 700 N (< 7,5 mm) S ≥ 1.300 N (> 7,5 mm)  R ≥ 35 N/mm <sup>2</sup> .	S ≥ 2.800 N R ≥ 49 N/mm <sup>2</sup> (formato 600x600 24"x24" size)
<b>RESISTENZA ALL'URTO</b> IMPACT RESISTANCE - STOSSFESTIGKEIT RESISTANCE AUX CHOCS - RESISTENCIA A LOS GOLPES УДАРОСТОЙКОСТЬ - 抗冲击强度	EN ISO 10545-5	VALORE DICHIARATO DECLARED VALUE	> 0,80
<b>RESISTENZA ALL'ABRASIONE</b> ABRASION RESISTANCE - ABRIEFESTIGKEIT RESISTANCE A L'ABRASION - RESISTENCIA A LA ABRASIÓN СТОЙКОСТЬ К ИСТИРАНИЮ - 耐磨强度	EN ISO 10545-6	≤ 175 mm <sup>3</sup>	< 150 mm <sup>3</sup>
<b>COEFFICIENTE DI DILATAZIONE TERMICA LINEARE</b> COEFFICIENT OF LINEAR THERMAL-EXPANSION - LINEARER WÄRMEAUSSDEHNUNGSKOEFFIZIENT COEFFICIENT DE DILATATION THERMIQUE LINEAIRE - COEFICIENTE DE DILATACIÓN TÉRMICA LINEAL КОЭФФИЦИЕНТ ЛИНЕЙНОГО ТЕРМИЧЕСКОГО РАСШИРЕНИЯ - 线性热膨胀系数	EN ISO 10545-8	—	α=7,3x10 <sup>-6</sup> °C <sup>-1</sup>
<b>RESISTENZA AGLI SBALZI TERMICI</b> RESISTANCE TO THERMAL SHOCKS - BESTÄNDIGKEIT GEGEN TEMPERATURSCHWANKUNGEN RESISTANCE AUX CHOCS THERMIQUES - RESISTENCIA A LOS CHOQUES TÉRMICOS СТОЙКОСТЬ К ПЕРЕПАДАМ ТЕМПЕРАТУРЫ - 耐热突变性	EN ISO 10545-9	TEST SUPERATO SECONDO EN ISO 10545-1 PASS ACCORDING EN ISO 10545-1	NESSUN DANNO NO DAMAGE
<b>RESISTENZA AL GELO</b> FROST RESISTANCE - FROSTBESTÄNDIGKEIT RESISTANCE AU GEL - RESISTENCIA AL HIELO МОРОЗОСТОЙКОСТЬ - 耐冻性	EN ISO 10545-12	TEST SUPERATO SECONDO EN ISO 10545-1 PASS ACCORDING EN ISO 10545-1	NESSUN DANNO NO DAMAGE
<b>RESISTENZA ALL'ATTACCO CHIMICO</b> RESISTANCE TO CHEMICALS - CHEMIKALIENBESTÄNDIGKEIT RESISTANCE A L'ATTAQUE CHIMIQUE - RESISTENCIA QUÍMICA ХИМИЧЕСКАЯ СТОЙКОСТЬ - 耐化学品作用	EN ISO 10545-13	UB MIN.	UA ULA UHA
<b>RESISTENZA ALLE MACCHIE</b> RESISTANCE TO STAINS - FLECKENBESTÄNDIGKEIT RESISTANCE AUX TACHES - RESISTENCIA A LAS MANCHAS УСТОЙЧИВОСТЬ К ПЯТНООБРАЗОВАНИЮ - 防污性	EN ISO 10545-14	VALORE DICHIARATO DECLARED VALUE	5
<b>CESSIONE DI PIOMBO E CADMIO</b> LEAD AND CADMIUM DISCHARGE - ABGABE VON BLEI UND CADMIUM PERTE DE PLOMB ET CADMIUM - CESIÓN DE PLOMO Y CADMIO ВЫДЕЛЕНИЕ СВИНЦА И КАДМИЯ - 铅和镉的排放	EN ISO 10545-15	VALORE DICHIARATO DECLARED VALUE	< AL LIMITE DI RILEVAMENTO < THAN INSTRUMENT LIMIT
			NAT
	<b>DM. 236/89 BCRA</b>	> 0,40	> 0,40
	<b>ASTM C1028</b>	SCOF > 0,60	> 0,60
	<b>ANSI A137.1</b>	Wet DCOF > 0,42	> 0,42
	<b>AS 4586:2013</b>	-	-
	<b>DIN 51130</b>	-	R9
	<b>DIN 51097</b>	-	-
	<b>ENV 12633</b>	≥ CL1	CL1
	<b>BS 7976</b>	≥ 36	≥ 36
<b>SCIVOLOSITÀ</b> SKID RESISTANCE - RUTSCHWERT GLISSANCE - ADHERENCIA			



**CERAGRÉS**  
LUXE

**CERAGRES CERAMICS PRIVATE LIMITED**  
7th & 8th Floor, Mascots, Times Square Building,  
Western Expressway Highway, Andheri (EAST),  
Mumbai, Maharashtra (INDIA)-400069  
[touch@ceragresceramics.com](mailto:touch@ceragresceramics.com)  
[www.ceragresceramics.com](http://www.ceragresceramics.com)