

**CERAGRÉS**  
LUXE

---

**CORE**



LUXE



rivestimento Core Anthracite 800x1600  
rivestimento Core Gypsum 800x800  
pavimento Core Gypsum 800x1600



# CORE

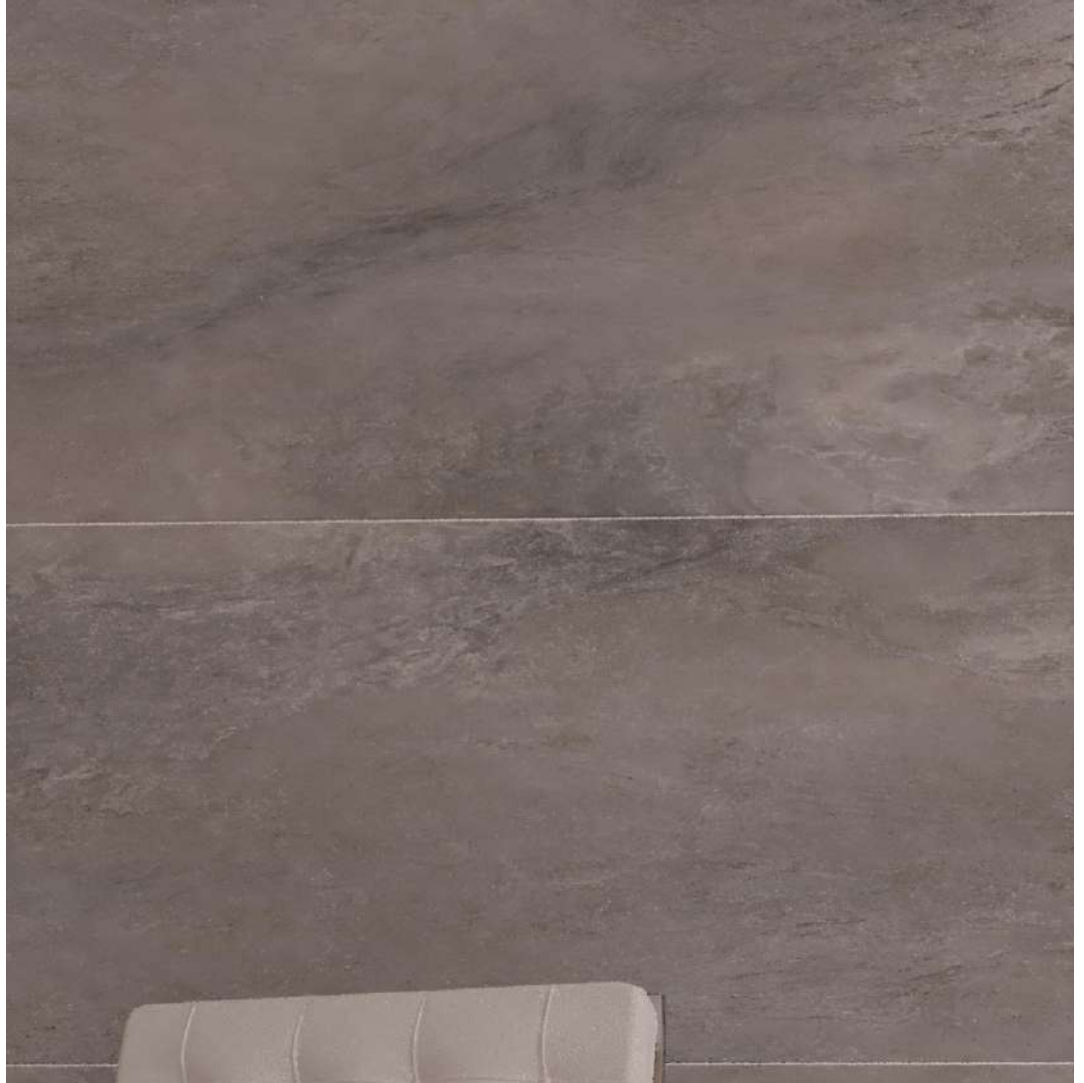

rivestimento Core Anthracite 800x1600



# CORE

Colori . Colours . Couleurs . Colores



Gypsum



Crema



Coco



Anthracite

Formati . Sizes . Formats . Formatos

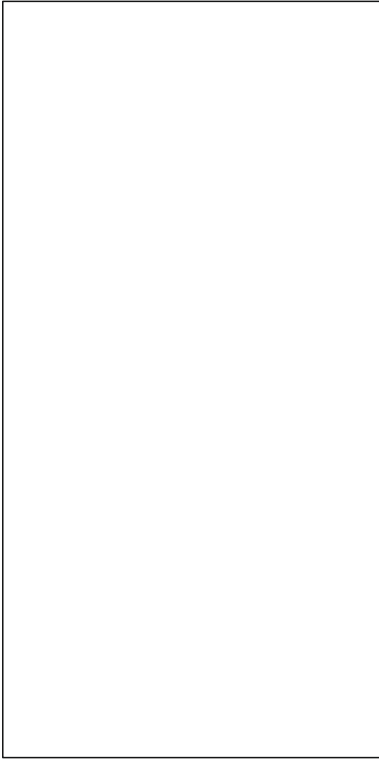

80x160 R  
32"x64"  
771551 Core Gypsum  
771552 Core Crema  
771553 Core Coco  
771554 Core Anthracite

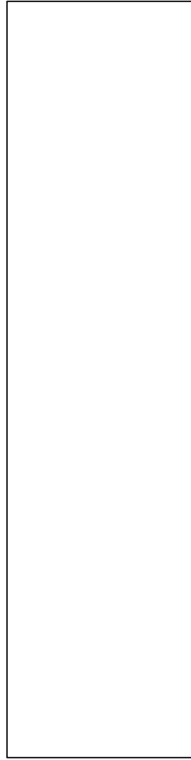

40x160 R  
16"x64"  
771555 Core Gypsum  
771556 Core Crema  
771557 Core Coco  
771558 Core Anthracite



A95



20x160 R  
8"x64"  
771559 Core Gypsum  
771560 Core Crema  
771561 Core Coco  
771562 Core Anthracite



10x160 R  
4"x64"  
771563 Core Gypsum  
771564 Core Crema  
771565 Core Coco  
771566 Core Anthracite



A95



Formati . Sizes . Formats . Formatos

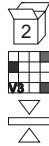
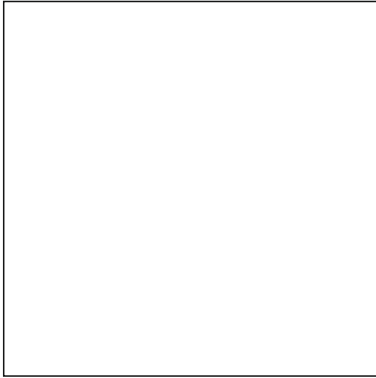

80x80 R  
32"x32"  
771567 Core Gypsum  
771568 Core Crema  
771569 Core Coco  
771570 Core Anthracite



A95



40x80 R  
16"x32"  
771571 Core Gypsum  
771572 Core Crema  
771573 Core Coco  
771574 Core Anthracite



A95

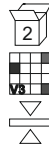

20x80 R  
8"x32"  
771575 Core Gypsum  
771576 Core Crema  
771577 Core Coco  
771578 Core Anthracite



A95

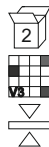

10x80 R  
4"x32"  
771579 Core Gypsum  
771580 Core Crema  
771581 Core Coco  
771582 Core Anthracite



A95

## Formati . Sizes . Formats . Formatos

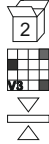
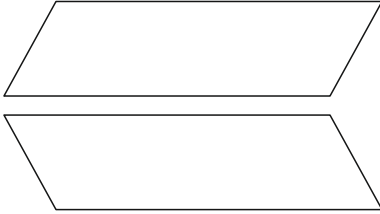

20x80 R  
8"x32"



771583 Core Gypsum L  
771584 Core Gypsum R  
771585 Core Crema L  
771586 Core Crema R  
771587 Core Coco L  
771588 Core Coco R  
771589 Core Anthracite L  
771590 Core Anthracite R

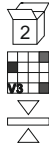
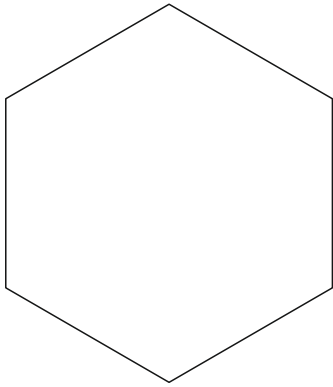

70x80 R  
28"x32"



771591 Core Gypsum  
771592 Core Crema  
771593 Core Coco  
771594 Core Anthracite



**CORE**



CORE

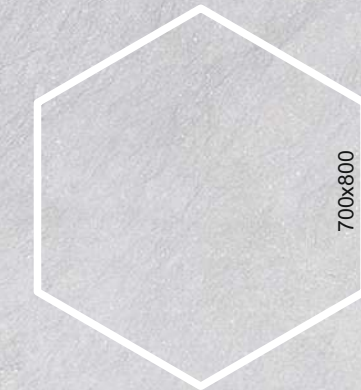

Formati . Sizes . Formats . Formatos



80x160 R  
32"x64"  
771551 Core Gypsum

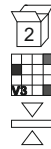

40x160 R  
16"x64"  
771555 Core Gypsum



A95

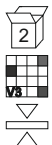

20x160 R  
8"x64"  
771559 Core Gypsum

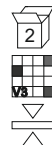

10x160 R  
4"x64"  
771563 Core Gypsum



A95



Formati . Sizes . Formats . Formatos

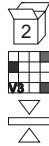

80x80 R  
32"x32"  
771567 Core Gypsum



A95

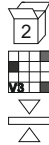

40x80 R  
16"x32"  
771571 Core Gypsum



A95

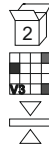

20x80 R  
8"x32"  
771575 Core Gypsum



A95

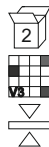

10x80 R  
4"x32"  
771579 Core Gypsum



A95

## Formati . Sizes . Formats . Formatos

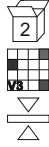

20x80 R  
8"x32"  
771583 Core Gypsum L  
771584 Core Gypsum R

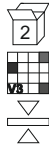

70x80 R  
28"x32"  
771591 Core Gypsum



CORE

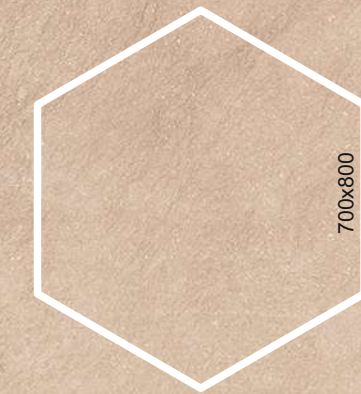



Formati . Sizes . Formats . Formatos



80x160 R  
32"x64"  
771552 Core Crema

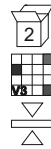

40x160 R  
16"x64"  
771556 Core Crema



A95



20x160 R  
8"x64"  
771560 Core Crema

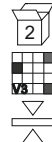

10x160 R  
4"x64"  
771564 Core Crema



A95

Formati . Sizes . Formats . Formatos

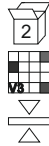

80x80 R  
32"x32"  
771568 Core Crema



A95

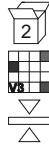

40x80 R  
16"x32"  
771572 Core Crema



A95

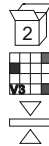

20x80 R  
8"x32"  
771576 Core Crema



A95



10x80 R  
4"x32"  
771580 Core Crema



A95

## Formati . Sizes . Formats . Formatos



20x80 R  
8"x32"  
771585 Core Crema L  
771586 Core Crema R

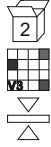

70x80 R  
28"x32"  
771592 Core Crema

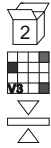



CORE

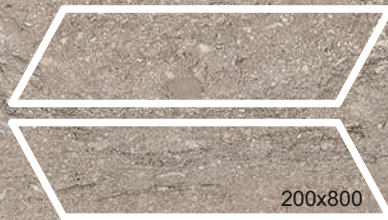
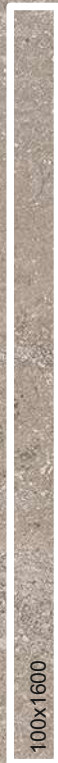
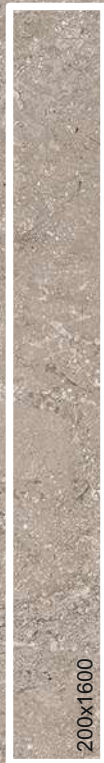



Formati . Sizes . Formats . Formatos



80x160 R  
32"x64"  
771553 Core Coco

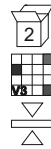

40x160 R  
16"x64"  
771557 Core Coco



A95

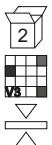

20x160 R  
8"x64"  
771561 Core Coco

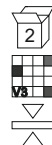

10x160 R  
4"x64"  
771565 Core Coco



A95

Formati . Sizes . Formats . Formatos

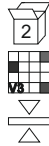

80x80 R  
32"x32"  
771569 Core Coco



A95

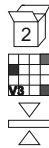

40x80 R  
16"x32"  
771573 Core Coco



A95

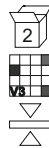

20x80 R  
8"x32"  
771577 Core Coco



A95



10x80 R  
4"x32"  
771581 Core Coco



A95

## Formati . Sizes . Formats . Formatos

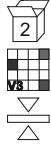

20x80 R  
8"x32"  
771587 Core Coco L  
771588 Core Coco R

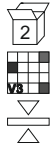

70x80 R  
28"x32"  
771593 Core Coco





CORE

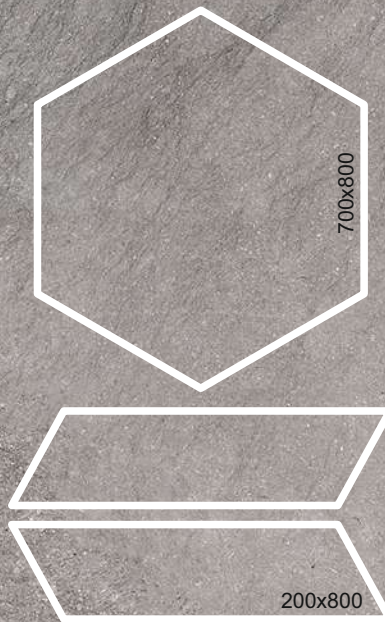
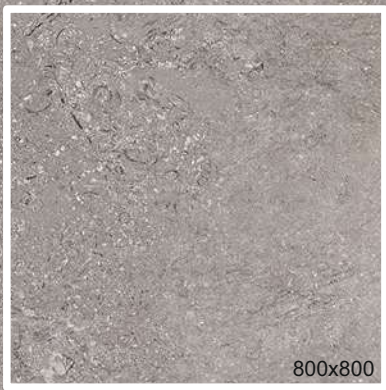



Formati . Sizes . Formats . Formatos



80x160 R  
32"x64"  
771554 Core Anthracite

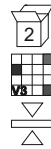

40x160 R  
16"x64"  
771558 Core Anthracite



A95

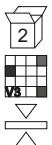

20x160 R  
8"x64"  
771562 Core Anthracite

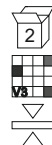

10x160 R  
4"x64"  
771566 Core Anthracite



A95



Formati . Sizes . Formats . Formatos

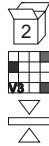

80x80 R  
32"x32"  
771570 Core Anthracite



A95

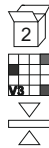

40x80 R  
16"x32"  
771574 Core Anthracite



A95

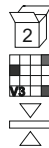

20x80 R  
8"x32"  
771578 Core Anthracite



A95

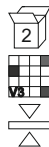

10x80 R  
4"x32"  
771582 Core Anthracite



A95

Formati . Sizes . Formats . Formatos

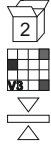

20x80 R  
8"x32"  
771589 Core Anthracite L  
771590 Core Anthracite R

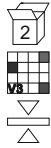

70x80 R  
28"x32"  
771594 Core Anthracite



rivestimento Core Crema 800x1600





## Grés Porcellanàto . Stoneware Porcelain . Ceràmè Gres . Gres Porcelánico

### Mòsaici . Mosaics . Mosaïques . Mosàicós

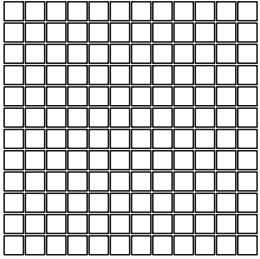

**Mosaici 12**  
30x30  
771595 Core Gypsum  
771596 Core Crema  
771597 Core Coco  
771598 Core Anthracite

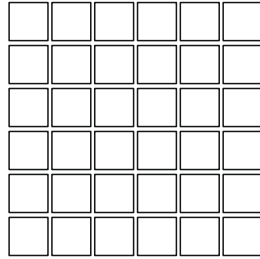

**Mosaici 6**  
30x30  
771599 Core Gypsum  
771600 Core Crema  
771601 Core Coco  
771602 Core Anthracite

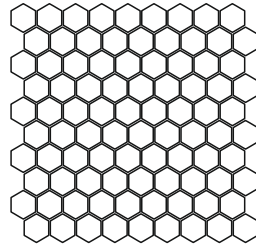

**Mosaici Hex 9**  
30x30  
771603 Core Gypsum  
771604 Core Crema  
771605 Core Coco  
771606 Core Anthracite

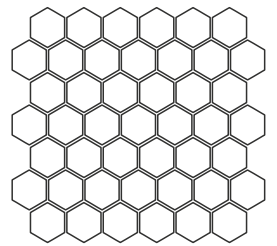

**Mosaici Hex 6**  
30x30  
771607 Core Gypsum  
771608 Core Crema  
771609 Core Coco  
771610 Core Anthracite

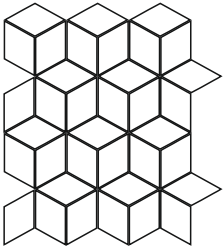

**Mosaici Topaz**  
30x30  
771611 Core Gypsum  
771612 Core Crema  
771613 Core Coco  
771614 Core Anthracite

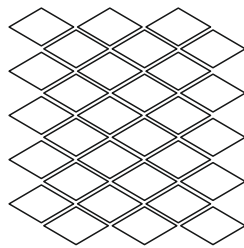

**Mosaici Prism**  
30x30  
771615 Core Gypsum  
771616 Core Crema  
771617 Core Coco  
771618 Core Anthracite

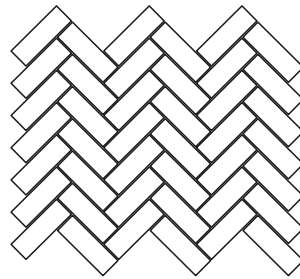

**Mosaici Herringbone 6**  
30x30  
771619 Core Gypsum  
771620 Core Crema  
771621 Core Coco  
771622 Core Anthracite

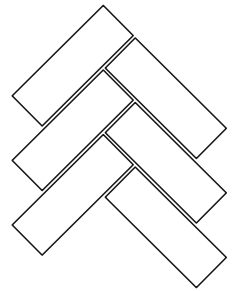

**Mosaici Herringbone 2**  
30x30  
771623 Core Gypsum  
771624 Core Crema  
771625 Core Coco  
771626 Core Anthracite

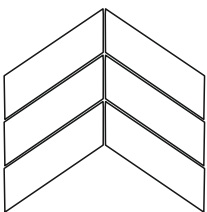

**Mosaici Chevron 2**  
30x30  
771627 Core Gypsum  
771628 Core Crema  
771629 Core Coco  
771630 Core Anthracite

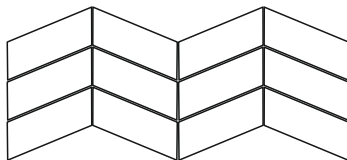

**Mosaici Chevron 4**  
30x30  
771631 Core Gypsum Anthracite  
771632 Core Crema Coco



Grés Porcellanàto . Stoneware Porcelain . Ceràme Gres . Gres Porcélanico

Mòsaici . Mosaics . Mosaiques . Mosàicós

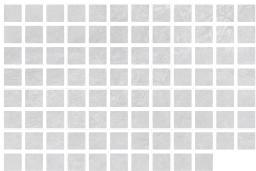

## Grés Porcellanàto . Stoneware Porcelain . Ceràme Gres . Gres Porcelánico

### Mòsaici . Mosaics . Mosaïques . Mosàicós

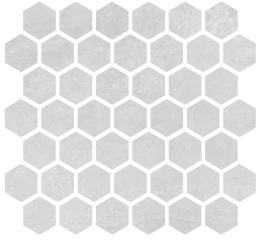

Mosaici Hex 6  
30x30  
771607 Core Gypsum

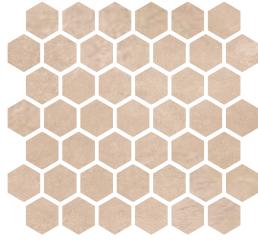

Mosaici Hex 6  
30x30  
771608 Core Crema

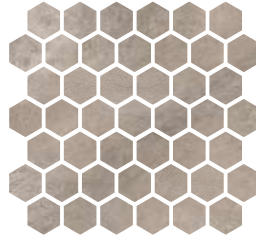

Mosaici Hex 6  
30x30  
771609 Core Coco

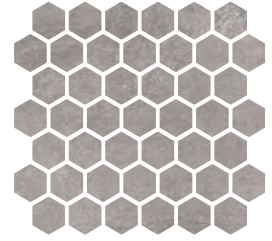

Mosaici Hex 6  
30x30  
771610 Core Anthracite

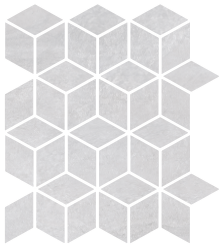

Mosaici Topaz  
30x30  
771611 Core Gypsum

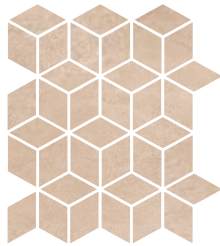

Mosaici Topaz  
30x30  
771612 Core Crema

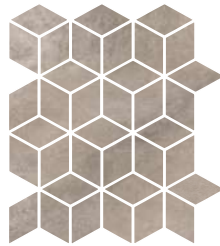

Mosaici Topaz  
30x30  
771613 Core Coco

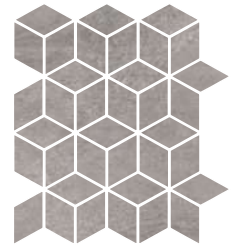

Mosaici Topaz  
30x30  
771614 Core Anthracite

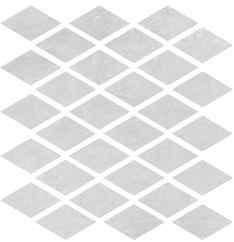

Mosaici Prism  
30x30  
771615 Core Gypsum

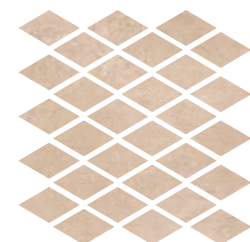

Mosaici Prism  
30x30  
771616 Core Crema

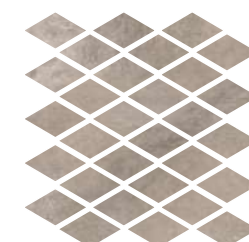

Mosaici Prism  
30x30  
771617 Core Coco

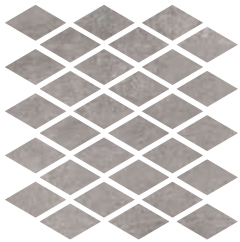

Mosaici Prism  
30x30  
771618 Core Anthracite

Grés Porcellanàto . Stoneware Porcelain . Ceràme Gres . Gres Porcelánico

Mòsaici . Mosaics . Mosaïques . Mosàicós

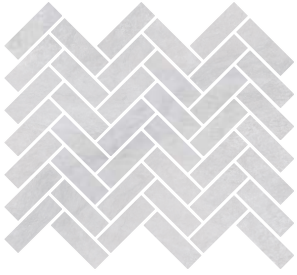

Mosaici Herringbone 6  
30x30  
771619 Core Gypsum

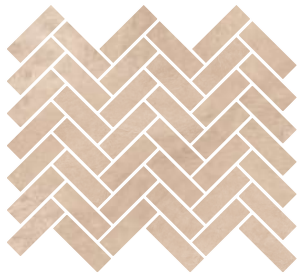

Mosaici Herringbone 6  
30x30  
771620 Core Crema

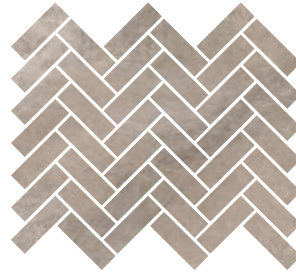

Mosaici Herringbone 6  
30x30  
771621 Core Coco



Mosaici Herringbone 6  
30x30  
771622 Core Anthracite



Mosaici Herringbone 2  
30x30  
771623 Core Gypsum

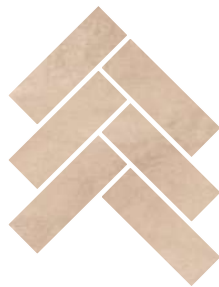

Mosaici Herringbone 2  
30x30  
771624 Core Crema



Mosaici Herringbone 2  
30x30  
771625 Core Coco

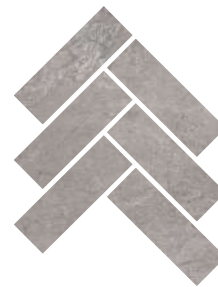

Mosaici Herringbone 2  
30x30  
771626 Core Anthracite

Grés Porcellanàto . Stoneware Porcelain . Ceràme Gres . Gres Porcèlanico

Mòsaici . Mosaics . Mosaïques . Mosàicós



Mosaici Chevron 2  
30x30  
771627 Core Gypsum

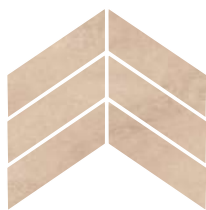

Mosaici Chevron 2  
30x30  
771628 Core Crema

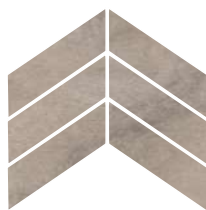

Mosaici Chevron 2  
30x30  
771629 Core Coco

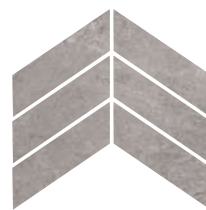

Mosaici Chevron 2  
30x30  
771630 Core Anthracite



Mosaici Chevron 4  
30x30  
771631 Core Gypsum Anthracite



Mosaici Chevron 4  
30x30  
771632 Core Crema Coco











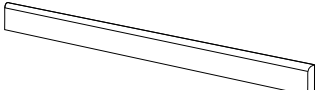

CORE



**Pezzi speciali . Trims . Pièces spéciales . Formstücke . Piezas especiales .**

	 <b>BATTISCOPA</b>	 <b>GRADINO</b>	 <b>SCALINO</b>
	100x1600	300x1600	200x1600
	<b>A150</b> 	<b>A250</b> 	<b>A125</b> 
GYPSUM	771633	771637	771641
CREMA	771634	771638	771642
COCO	771635	771639	771643
ANTHRACITE	771636	771640	771644

**Imballi . Packing . Conditionnement . Verpackungseinheiten . Embalajes .**

FORMATO SIZE FORMAT FORMAT FORMATO	SPESSORE THICKNESS EPAISSEUR STÄRKE ESPESOR	KG/MQ KG/SQM KG/MC KG/QM KG/MQ	SCATOLA		EUROPALLET	
			BOX BÔTE KARTON CAJA КОБОБКА		box	m <sup>q</sup>
				m <sup>q</sup>	box	m <sup>q</sup>
<b>80x160</b> . 32"x64"	9 mm . 0,35"	30	2	1.43	32	45.82
<b>80x80</b> . 32"x32"	9 mm . 0,35"	30	4	1.43	40	57.20
<b>40x160</b> . 16"x64"	9 mm . 0,35"	30	4	1.43	-	-
<b>40x80</b> . 16"x32"	9 mm . 0,35"	19	5	0.92	-	-
<b>20x160</b> . 8"x64"	9 mm . 0,35"	30	6	1.43	-	-
<b>20x80</b> . 8"x32"	9 mm . 0,35"	34	10	1.11	-	-
<b>30x30</b> . 12"x12"	9 mm . 0,35"	34	10	1.11	-	-

# CARATTERISTICHE TECNICHE

Technical specifications | Technische Eigenschaften | Caractéristiques techniques | Características técnicas |

## STANDARD EN 14411 - G

CARATTERISTICHE TECNICHE TECHNICAL DATA TECHNISCHE DATEN CARACTERISTIQUES TECHNIQUES	NORMA STANDARD NORM NORME	VALORI PRESCRITTI DALLE NORME EN 14411 - G INTERNATIONAL STANDARDS EN 14411 - G INTERNATIONALE NORMWERTE EN 14411 - G VALEURS PREVUES PAR LES NORMES EN 14411 - G	VALORE MEDIO CERAGRES CERAGRES AVERAGE VALUE CERAGRES MITTELWERT VALEURS MOYEN CERAGRES
<b>CARATTERISTICHE DIMENSIONALI</b> - SIZE CHARACTERISTICS - MASSEIGENSCHAFTEN DETERMINATION DES CARACTERISTIQUES DIMENSIONELLES - CARACTERÍSTICAS DIMENSIONALES - РАЗМЕРНЫЕ ХАРАКТЕРИСТИКИ - 尺寸特征			<b>NAT (UGL)</b>
<b>LATI</b> SIDES - SEITEN COTES - CANTOS РАЗМЕРЫ СТОРОН - 側邊	EN ISO 10545-2	± 0,3% MAX (± 1,0 mm MAX)	CONFORME COMPLYING
<b>SPESSORE</b> THICKNESS - DICKE ÉPAISSEUR - ESPESOR ТОЛЩИНА - 厚度	EN ISO 10545-2	± 5,0% MAX (± 0,5 mm MAX)	CONFORME COMPLYING
<b>RETTILINEITÀ DEGLI SPIGOLI</b> STRAIGHTNESS OF SIDES - GERADLINIGKEIT DER KANTEN RECTITUDE DES ARETES - RECTIDUD DE LOS CANTOS КОСОУГОЛЬНОСТЬ - 边角平直度	EN ISO 10545-2	± 0,3% MAX (± 0,8 mm MAX)	CONFORME COMPLYING
<b>ORTOGONALITÀ</b> RECTANGULARITY - RECHTWINKLIGKEIT PERPENDICULARITÉ - ORTOGONALIDAD КРИВИЗНА СТОРОН - 直角度	EN ISO 10545-2	± 0,3% MAX (± 1,5 mm MAX)	CONFORME COMPLYING
<b>PLANARITÀ</b> SURFACE FLATNESS - EBENFLÄCHIGKEIT PLANEITE DE SURFACE - PLANEIDAD КРИВИЗНА ЛИЦЕВОЙ ПОВЕРХНОСТИ - 平整度	EN ISO 10545-2	± 0,4% MAX (± 1,8 mm MAX)	CONFORME COMPLYING
<b>ASSORBIMENTO D'ACQUA</b> WATER ABSORPTION - WASSERAUFNAHME ABSORPTION D'EAU - ABSORCIÓN DE AGUA ВОДОПОГЛОЩЕНИЕ - 吸水率	EN ISO 10545-3	≤ 0,5%	≤ 0,1%
<b>RESISTENZA ALLA FLESSIONE</b> FLEXION RESISTANCE - BIEGEFESTIGKEIT RESISTANCE A LA FLEXION - RESISTENCIA A LA FLEXIÓN ПРЕДЕЛ ПРОЧНОСТИ ПРИ ИЗГИБЕ - 抗弯强度	EN ISO 10545-4	S ≥ 700 N (< 7,5 mm) S ≥ 1.300 N (> 7,5 mm)  R ≥ 35 N/mm².	S ≥ 2.800 N R ≥ 49 N/mm² (formato 600x600 24"x24" size)
<b>RESISTENZA ALL'URTO</b> IMPACT RESISTANCE - STOSSFESTIGKEIT RESISTANCE AUX CHOCS - RESISTENCIA A LOS GOLPES УДАРОСТОЙКОСТЬ - 抗冲击强度	EN ISO 10545-5	VALORE DICHIARATO DECLARED VALUE	> 0,80
<b>RESISTENZA ALL'ABRASIONE</b> ABRASION RESISTANCE - ABRIEBFESTIGKEIT RESISTANCE A L'ABRASION - RESISTENCIA A LA ABRASIÓN СТОЙКОСТЬ К ИСТИРАНИЮ - 耐磨强度	EN ISO 10545-6	≤ 175 mm³	< 150 mm³
<b>COEFFICIENTE DI DILATAZIONE TERMICA LINEARE</b> COEFFICIENT OF LINEAR THERMAL-EXPANSION - LINEARER WÄRMEAUSSDEHNUNGSKOEFFIZIENT COEFFICIENT DE DILATATION THERMIQUE LINEAIRE - COEFICIENTE DE DILATACIÓN TÉRMICA LINEAL КОЭФФИЦИЕНТ ЛИНЕЙНОГО ТЕРМИЧЕСКОГО РАСШИРЕНИЯ - 线性热膨胀系数	EN ISO 10545-8	—	α=7,3x10 <sup>-6</sup> °C <sup>-1</sup>
<b>RESISTENZA AGLI SBALZI TERMICI</b> RESISTANCE TO THERMAL SHOCKS - BESTÄNDIGKEIT GEGEN TEMPERATURSCHWANKUNGEN RESISTANCE AUX CHOCS THERMIQUES - RESISTENCIA A LOS CHOQUES TÉRMICOS СТОЙКОСТЬ К ПЕРЕПАДАМ ТЕМПЕРАТУРЫ - 耐热突变性	EN ISO 10545-9	TEST SUPERATO SECONDO EN ISO 10545-1 PASS ACCORDING EN ISO 10545-1	NESSUN DANNO NO DAMAGE
<b>RESISTENZA AL GELO</b> FROST RESISTANCE - FROSTBESTÄNDIGKEIT RESISTANCE AU GEL - RESISTENCIA AL HIELO МОРОЗОСТОЙКОСТЬ - 耐冻性	EN ISO 10545-12	TEST SUPERATO SECONDO EN ISO 10545-1 PASS ACCORDING EN ISO 10545-1	NESSUN DANNO NO DAMAGE
<b>RESISTENZA ALL'ATTACCO CHIMICO</b> RESISTANCE TO CHEMICALS - CHEMIKALIENBESTÄNDIGKEIT RESISTANCE A L'ATTAQUE CHIMIQUE - RESISTENCIA QUÍMICA ХИМИЧЕСКАЯ СТОЙКОСТЬ - 耐化学品作用	EN ISO 10545-13	UB MIN.	UA ULA UHA
<b>RESISTENZA ALLE MACCHIE</b> RESISTANCE TO STAINS - FLECKENBESTÄNDIGKEIT RESISTANCE AUX TACHES - RESISTENCIA A LAS MANCHAS УСТОЙЧИВОСТЬ К ПЯТНООБРАЗОВАНИЮ - 防污性	EN ISO 10545-14	VALORE DICHIARATO DECLARED VALUE	5
<b>CESSIONE DI PIOMBO E CADMIO</b> LEAD AND CADMIUM DISCHARGE - ABGABE VON BLEI UND CADMIUM PERTE DE PLOMB ET CADMIUM - CESIÓN DE PLOMO Y CADMIO ВЫДЕЛЕНИЕ СВИНЦА И КАДМИЯ - 铅和镉的排放	EN ISO 10545-15	VALORE DICHIARATO DECLARED VALUE	< AL LIMITE DI RILEVAMENTO < THAN INSTRUMENT LIMIT
			NAT
	<b>DM. 236/89 BCRA</b>	> 0,40	> 0,40
	<b>ASTM C1028</b>	SCOF > 0,60	> 0,60
	<b>ANSI A137.1</b>	Wet DCOF > 0,42	> 0,42
	<b>AS 4586:2013</b>	-	-
	<b>DIN 51130</b>	-	R9
	<b>DIN 51097</b>	-	-
	<b>ENV 12633</b>	≥ CL1	CL1
	<b>BS 7976</b>	≥ 36	≥ 36
<b>SCIVOLOSITÀ</b> SKID RESISTANCE - RUTSCHWERT GLISSANCE - ADHERENCIA			





**CERAGRÉS**  
LUXE

**CERAGRES CERAMICS PRIVATE LIMITED**  
7th & 8th Floor, Mascots, Times Square Building,  
Western Expressway Highway, Andheri (EAST),  
Mumbai, Maharashtra (INDIA)-400069  
[touch@ceragresceramics.com](mailto:touch@ceragresceramics.com)  
[www.ceragresceramics.com](http://www.ceragresceramics.com)