

CÉRÀGRÈS
LUXE

ALWAYS



La collezione "Always" ha un sapore contemporaneo: macchie, nuvolature e lievi graffi ravvivano la tinta unita dell'ardesia, esaltando il carattere della materia utilizzata e rendendola piú attuale. La palette cromatica estremamente contemporanea é caratterizzata da quattro colori neutri sfumature. Le superfici riproducono con estremo realismo e profonditá di colore I diversi aspetti naturali della pietra, dalle minime ombreggiature alle inclusioni granulari, offrendo prestazioni superiori in termini di durabilitá, resistenza e igiene.

Collection "Always" has a contemporary feel: stains, cloudy effects and slight scratches enliven the plain colour of the slate, bringing out the character of the material used and making it more up-to-date. The extremely contemporary colour palette features four neutral shades. The surface reproduce the various natural looks of stone with extreme realism and depth of colour, from minimum shading to granular inclusions, offering superior performance in terms of durability, resistance and hygiene.

La collection "Always" a un esprit contemporain : taches, effets nuageux et légères rayures animent la couleur unie de l'ardoise, faisant ressortir le caractère du matériau utilisé et le rendant plus actuel. La palette de couleurs extrêmement contemporaine comprend quatre couleurs neutres. nuances. Les surfaces reproduisent les différents aspects naturels de la pierre avec un réalisme extreme et une profondeur de couleur, depuis les nuances minimales jusqu'aux inclusions granulaires, offrant des performances supérieures en termes de durabilité, de résistance et d'hygiène.

La colección "Always" tiene un aire contemporáneo: manchas, efectos turbios y ligeros rayones animan el color liso de la pizarra, resaltando el carácter del material utilizado y haciéndola más actual. La paleta de colores, extremadamente contemporánea, presenta cuatro colores neutros. sombras. Las superficies reproducen los diversos aspectos naturales de la piedra con extremo realismo y profundidad de color, desde mínimas sombras hasta inclusiones granulares, ofreciendo un rendimiento superior en términos de durabilidad, resistencia e higiene.

ALWAYS



rivestimento Always Marfil 80x160
pavimento Always Marfil 80x160

ALWAYS

ALWAYS

Colori . Colours . Couleurs . Colores

pavimento Always Negro 80x80



Marfil

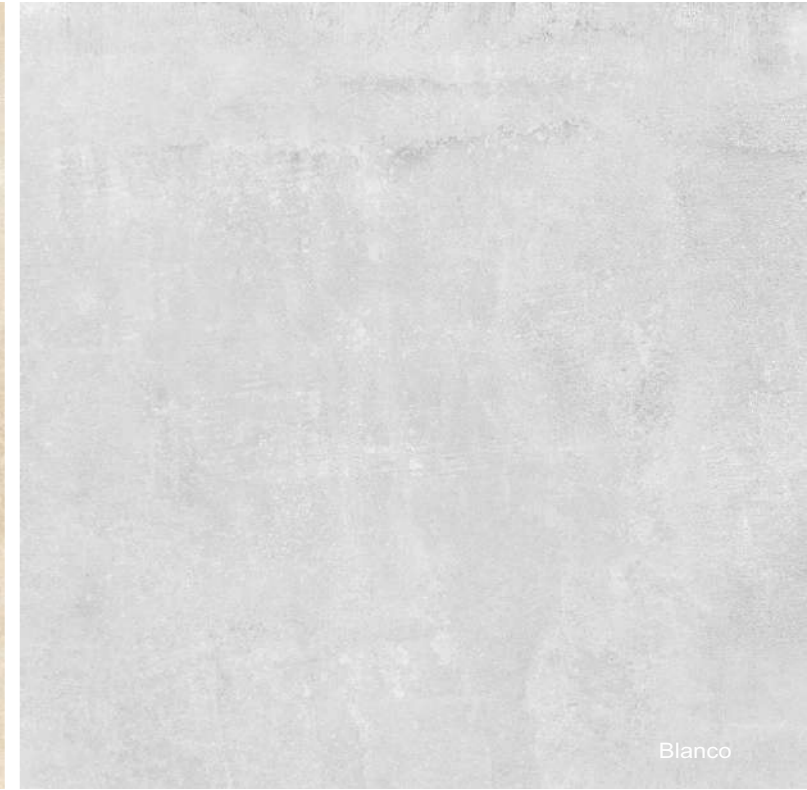

Blanco



Moka



Negro

Formati . Sizes . Formats . Formatos

Formati . Sizes . Formats . Formatos



80x160 R
32"x64"
770701 Always Marfil
770702 Always Bianco
770703 Always Moka
770704 Always Negro

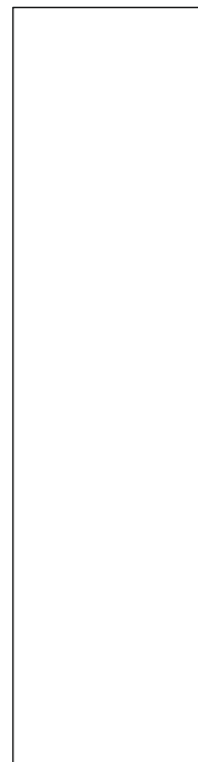

40x160 R
16"x64"
770705 Always Marfil
770706 Always Bianco
770707 Always Moka
770708 Always Negro



20x160 R
8"x64"
770709 Always Marfil
770710 Always Bianco
770711 Always Moka
770712 Always Negro



10x160 R
4"x64"
770713 Always Marfil
770714 Always Bianco
770715 Always Moka
770716 Always Negro

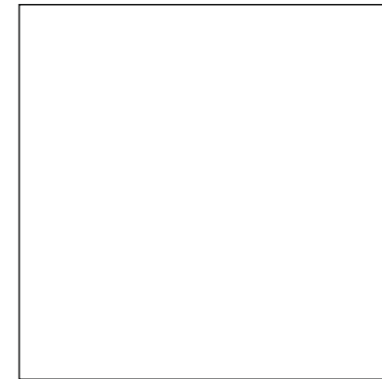

80x80 R
32"x32"
770717 Always Marfil
770718 Always Bianco
770719 Always Moka
770720 Always Negro

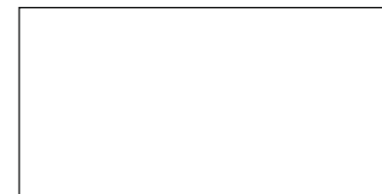

40x80 R
16"x32"
770721 Always Marfil
770722 Always Bianco
770723 Always Moka
770724 Always Negro

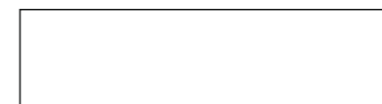

20x80 R
8"x32"
770725 Always Marfil
770726 Always Bianco
770727 Always Moka
770728 Always Negro

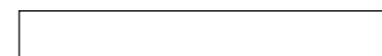

10x80 R
4"x32"
770729 Always Marfil
770730 Always Bianco
770731 Always Moka
770732 Always Negro

ALWAYS

ALWAYS

Formati . Sizes . Formats . Formatos

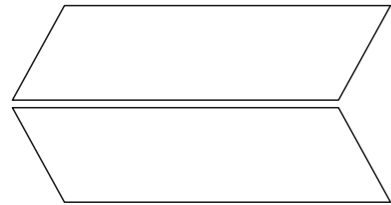

20x80 R
8"x32"
770733 Always Marfil L
770734 Always Marfil R
770735 Always Blanco L
770736 Always Blanco R
770737 Always Moka L
770738 Always Moka R
770737 Always Negro L
770738 Always Negro R

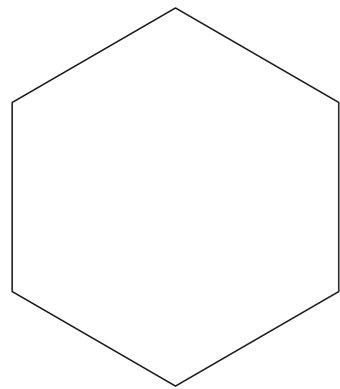

70x80 R
28"x32"
770739 Always Marfil
770740 Always Blanco
770741 Always Moka
770742 Always Negro

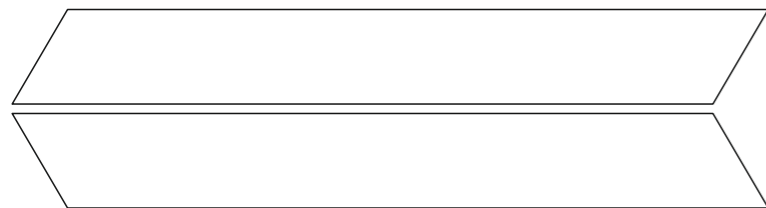

20x160 R
8"x64"
770793 Always Marfil L
770794 Always Marfil R
770795 Always Blanco L
770796 Always Blanco R
770797 Always Moka L
770798 Always Moka R
770799 Always Negro L
770800 Always Negro R

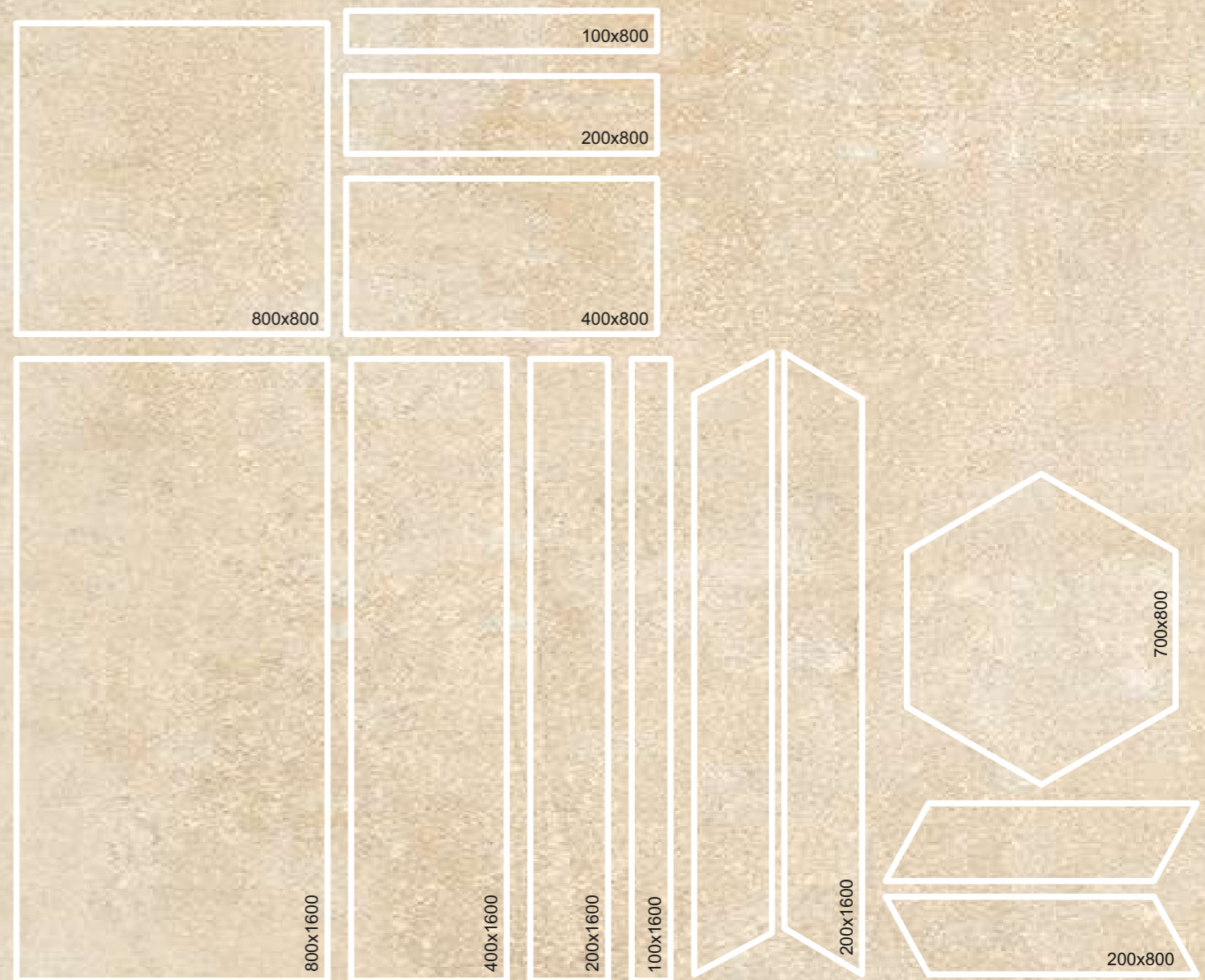

Formati . Sizes . Formats . Formatos

Formati . Sizes . Formats . Formatos



80x160 R
32"x64"
770701 Always Marfil

A160

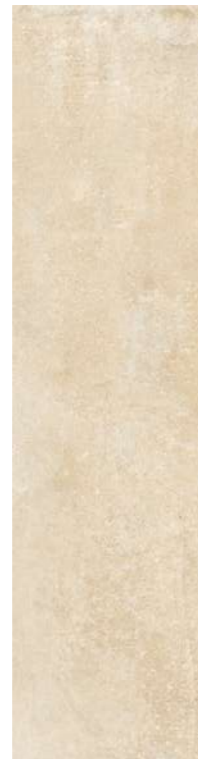

40x160 R
16"x64"
770705 Always Marfil

A150



20x160 R
8"x64"
770709 Always Marfil

A140



10x160 R
4"x64"
770713 Always Marfil

A130



Si consiglia la posa con fuga 2 mm. - Laying with a 2 mm-joint is recommended. - Pose recommandée avec joints de 2 mm. - Se recomienda la colocación con juntas de 2 mm.



80x80 R
32"x32"
770717 Always Marfil

A120



40x80 R
16"x32"
770721 Always Marfil

A110



20x80 R
8"x32"
770725 Always Marfil

A100



10x80 R
4"x32"
770729 Always Marfil

A90



Si consiglia la posa con fuga 2 mm. - Laying with a 2 mm-joint is recommended. - Pose recommandée avec joints de 2 mm. - Se recomienda la colocación con juntas de 2 mm.

ALWAYS



ALWAYS

Formati . Sizes . Formats . Formatos



20x80 R
8"x32"
770733 Always Marfil L
770734 Always Marfil R

A590



70x80 R
28"x32"
770739 Always Marfil

A640



20x160 R
8"x64"
770793 Always Marfil L
770794 Always Marfil R

A700



Si consiglia la posa con fuga 2 mm. - Laying with a 2 mm-joint is recommended. - Pose recommandée avec joints de 2 mm. - Se recomienda la colocación con juntas de 2 mm.

ALWAYS

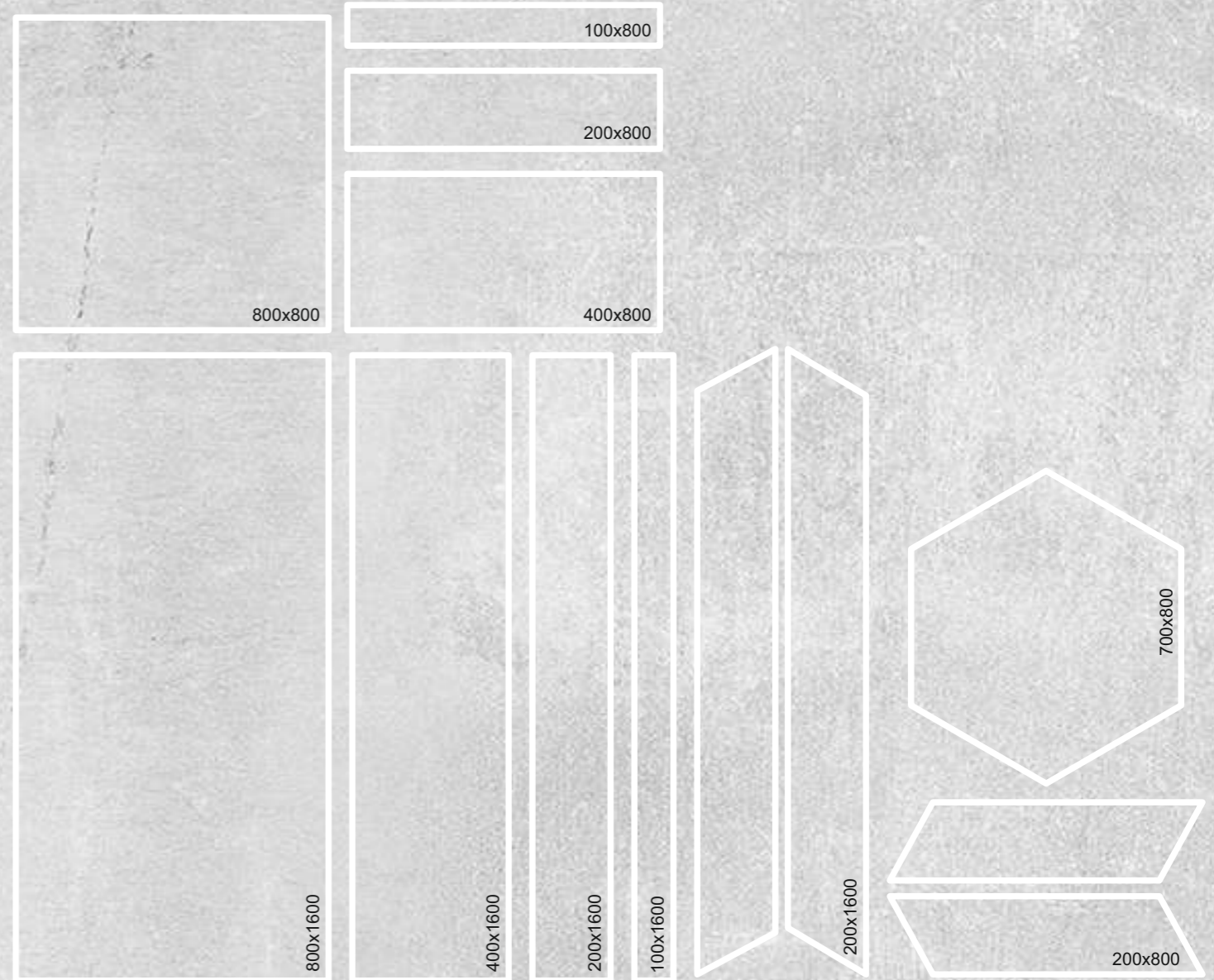

Formati . Sizes . Formats . Formatos

Formati . Sizes . Formats . Formatos



80x160 R
32"x64"
770701 Always Marfil

A160



40x160 R
16"x64"
770705 Always Marfil

A150



20x160 R
8"x64"
770709 Always Marfil

A140



10x160 R
4"x64"
770713 Always Marfil

A130



Si consiglia la posa con fuga 2 mm. - Laying with a 2 mm-joint is recommended. - Pose recommandée avec joints de 2 mm. - Se recomienda la colocación con juntas de 2 mm.

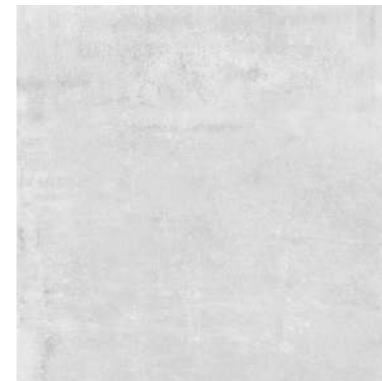

80x80 R
32"x32"
770718 Always Blanco

A120



40x80 R
16"x32"
770722 Always Blanco

A110



20x80 R
8"x32"
770726 Always Blanco

A100



10x80 R
4"x32"
770730 Always Blanco

A90



Si consiglia la posa con fuga 2 mm. - Laying with a 2 mm-joint is recommended. - Pose recommandée avec joints de 2 mm. - Se recomienda la colocación con juntas de 2 mm.

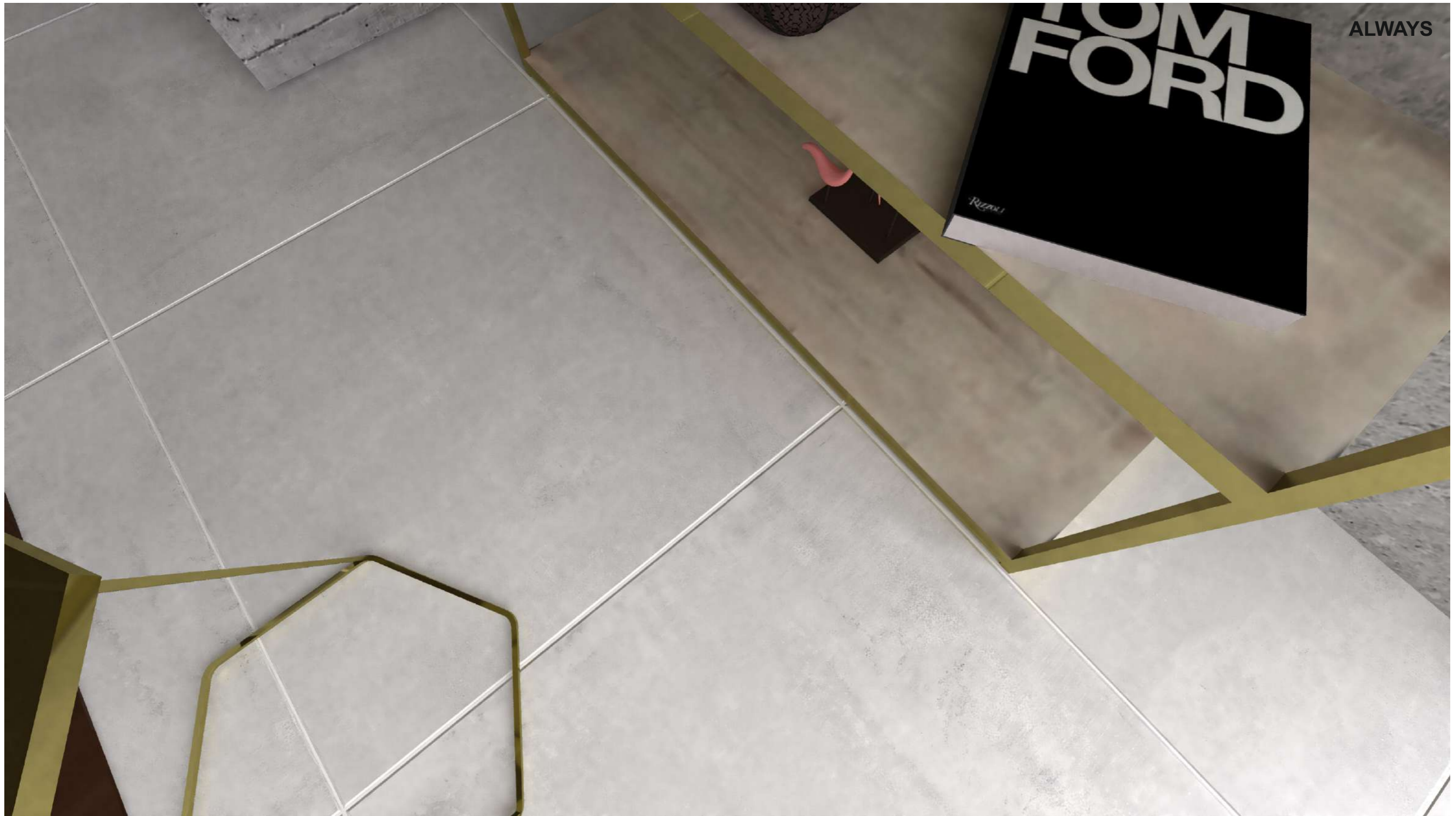

pavimento Always Blanco 80x80

ALWAYS

ALWAYS

Formati . Sizes . Formats . Formatos



20x80 R
8"x32"
770735 Always Blanco L
770736 Always Blanco R

A590



70x80 R
28"x32"
770740 Always Blanco

A640



20x160 R
8"x64"
770795 Always Blanco L
770796 Always Blanco R

A700



Si consiglia la posa con fuga 2 mm. - Laying with a 2 mm-joint is recommended. - Pose recommandée avec joints de 2 mm. - Se recomienda la colocación con juntas de 2 mm.

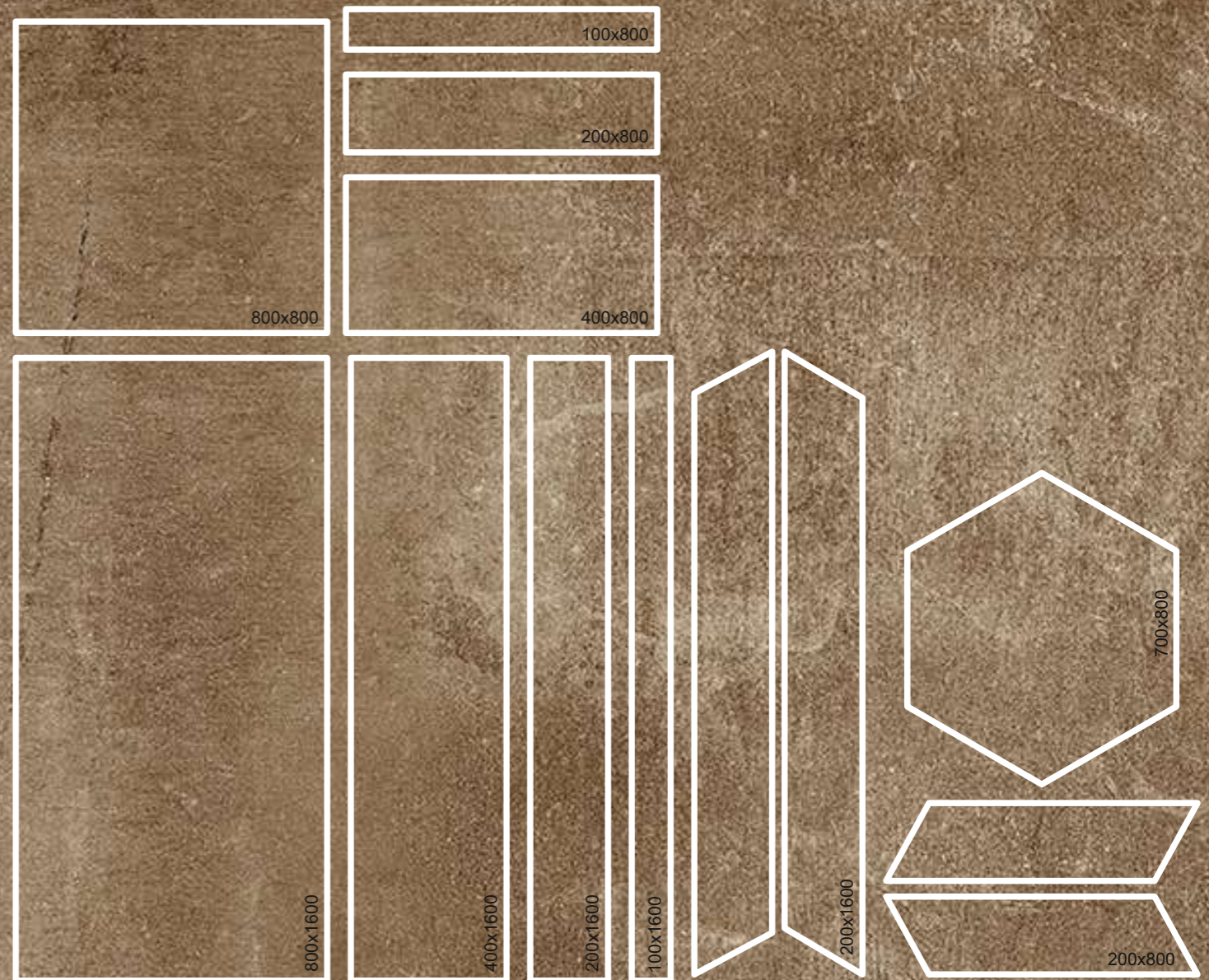

Formati . Sizes . Formats . Formatos

Formati . Sizes . Formats . Formatos



80x160 R
32"x64"
770703 Always Moka

A160



40x160 R
16"x64"
770707 Always Moka

A150



20x160 R
8"x64"
770711 Always Moka

A140



10x160 R
4"x64"
770715 Always Moka

A130



Si consiglia la posa con fuga 2 mm. - Laying with a 2 mm-joint is recommended. - Pose recommandée avec joints de 2 mm. - Se recomienda la colocación con juntas de 2 mm.



80x80 R
32"x32"
770719 Always Moka

A120



40x80 R
16"x32"
770723 Always Moka

A110



20x80 R
8"x32"
770727 Always Moka

A100



10x80 R
4"x32"
770731 Always Moka

A90



Si consiglia la posa con fuga 2 mm. - Laying with a 2 mm-joint is recommended. - Pose recommandée avec joints de 2 mm. - Se recomienda la colocación con juntas de 2 mm.

ALWAYS

ALWAYS

Formati . Sizes . Formats . Formatos



20x80 R
8"x32"
770737 Always Moka L
770738 Always Moka R

A590



70x80 R
28"x32"
770741 Always Moka

A640



20x160 R
8"x64"
770797 Always Moka L
770798 Always Moka R

A700



Si consiglia la posa con fuga 2 mm. - Laying with a 2 mm-joint is recommended. - Pose recommandée avec joints de 2 mm. - Se recomienda la colocación con juntas de 2 mm.

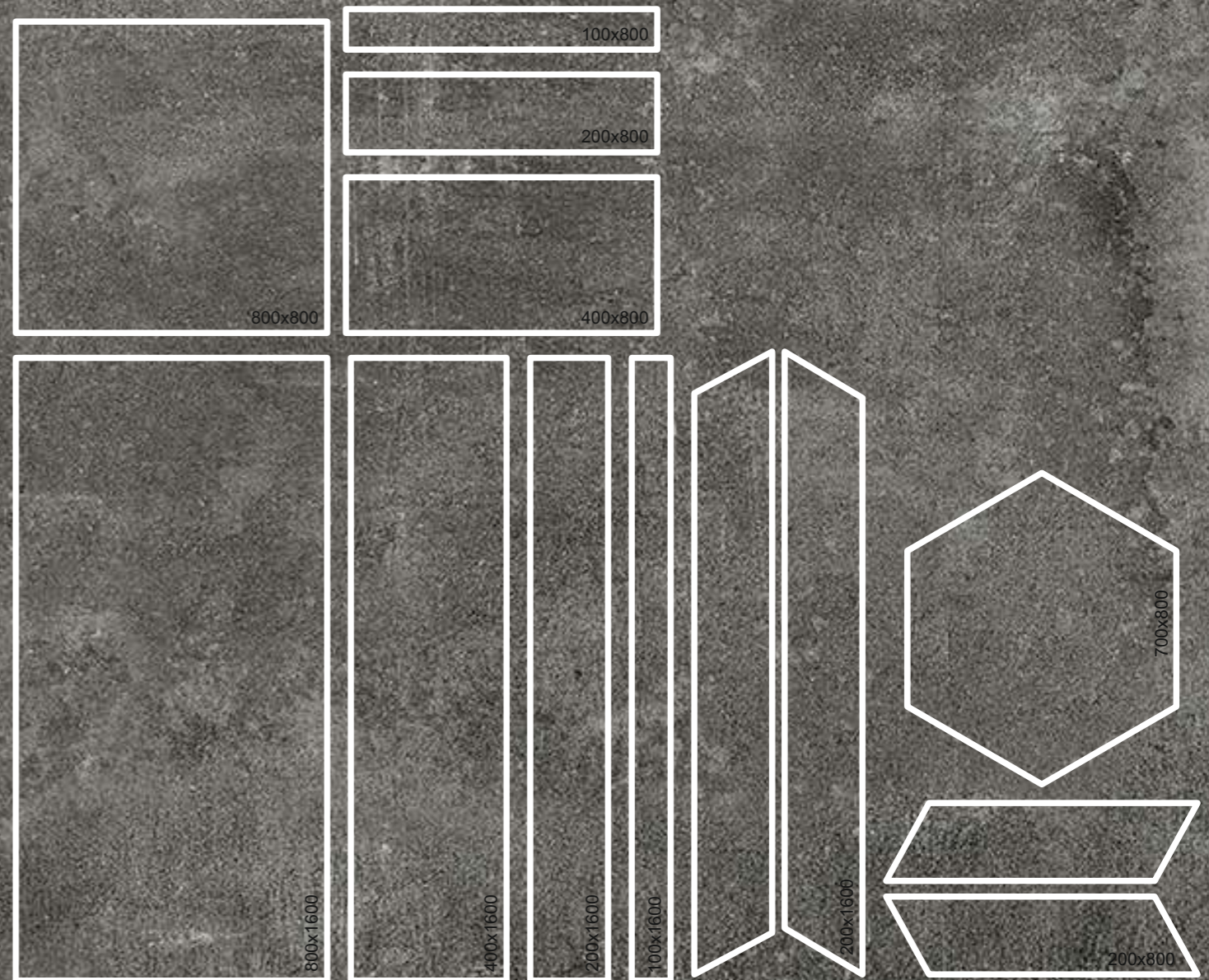

Formati . Sizes . Formats . Formatos

Formati . Sizes . Formats . Formatos



80x160 R
32"x64"
770704 Always Negro

A160



40x160 R
16"x64"
770708 Always Negro

A150



20x160 R
8"x64"
770712 Always Negro

A140



10x160 R
4"x64"
770716 Always Negro

A130



Si consiglia la posa con fuga 2 mm. - Laying with a 2 mm-joint is recommended. - Pose recommandée avec joints de 2 mm. - Se recomienda la colocación con juntas de 2 mm.



80x80 R
32"x32"
770720 Always Negro

A120



40x80 R
16"x32"
770724 Always Negro

A110



20x80 R
8"x32"
770728 Always Negro

A100



10x80 R
4"x32"
770732 Always Negro

A90



Si consiglia la posa con fuga 2 mm. - Laying with a 2 mm-joint is recommended. - Pose recommandée avec joints de 2 mm. - Se recomienda la colocación con juntas de 2 mm.

Formati . Sizes . Formats . Formatos



20x80 R
8"x32"
770737 Always Negro L
770738 Always Negro R

A590



70x80 R
28"x32"
770742 Always Negro

A640

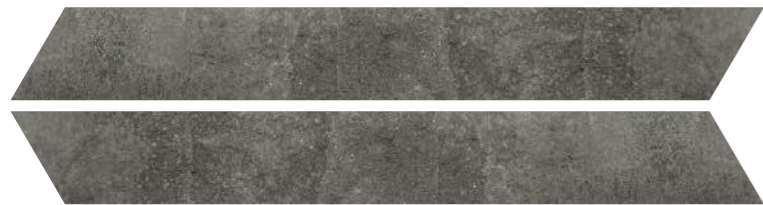

20x160 R
8"x64"
770799 Always Negro L
770800 Always Negro R

A700

Si consiglia la posa con fuga 2 mm. - Laying with a 2 mm-joint is recommended. - Pose recommandée avec joints de 2 mm. - Se recomienda la colocación con juntas de 2 mm.



pavimento Always Negro 80x80





Grés Porcellanàto . Stoneware Porcelain . Ceràme Gres . Gres Porcelánico

Grés Porcellanàto . Stoneware Porcelain . Ceràme Gres . Gres Porcelánico

Mòsaici . Mosaics . Mosaïques . Mosàicós

Mòsaici . Mosaics . Mosaïques . Mosàicós

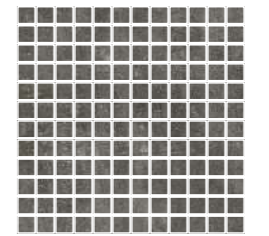
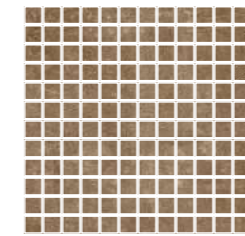
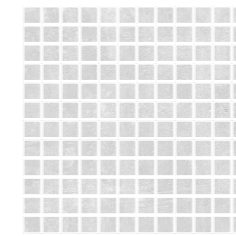
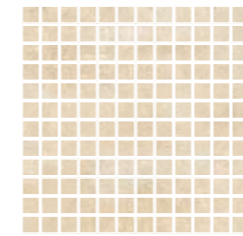
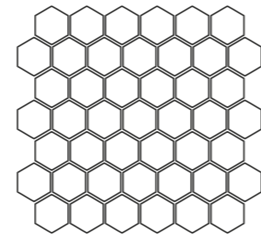
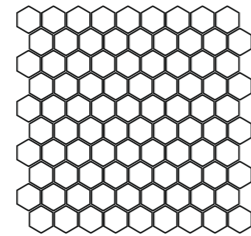
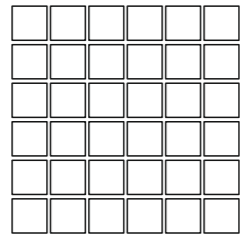
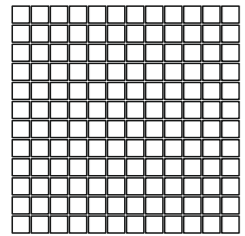

Mosaici 12
30x30
770743 Always Marfil
770744 Always Blanco
770745 Always Moka
770746 Always Negro

Mosaici 6
30x30
770747 Always Marfil
770748 Always Blanco
770749 Always Moka
770750 Always Negro

Mosaici Hex 9
29.4x29.8
770751 Always Marfil
770752 Always Blanco
770753 Always Moka
770754 Always Negro

Mosaici Hex 6
30.1x29.8
770755 Always Marfil
770756 Always Blanco
770757 Always Moka
770758 Always Negro

Mosaici 12
30x30
770743 Always Marfil

Mosaici 12
30x30
770744 Always Blanco

Mosaici 12
30x30
770745 Always Moka

Mosaici 12
30x30
770746 Always Negro

A990

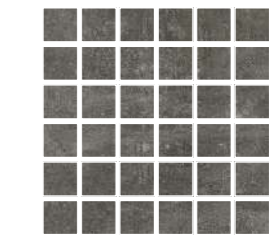
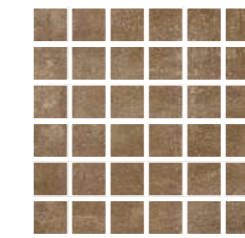
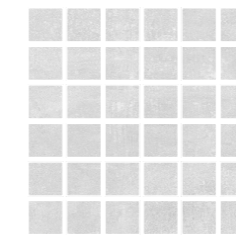
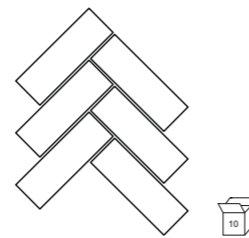
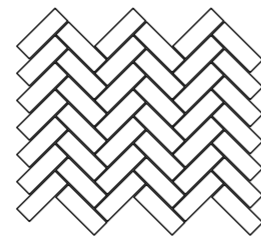
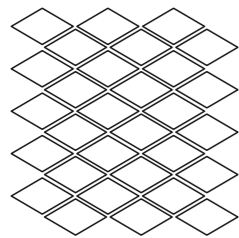
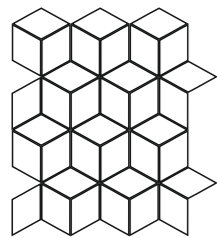

Mosaici Topaz
34.6x30
770759 Always Marfil
770760 Always Blanco
770761 Always Moka
770762 Always Negro

Mosaici Prism
29x30
770763 Always Marfil
770764 Always Blanco
770765 Always Moka
770766 Always Negro

Mosaici Herringbone 6
21.1x21.1
770767 Always Marfil
770768 Always Blanco
770769 Always Moka
770770 Always Negro

Mosaici Herringbone 2
28.3x30.5
770771 Always Marfil
770772 Always Blanco
770773 Always Moka
770774 Always Negro

Mosaici 6
30x30
770747 Always Marfil

Mosaici 6
30x30
770748 Always Blanco

Mosaici 6
30x30
770749 Always Moka

Mosaici 6
30x30
770750 Always Negro

A990

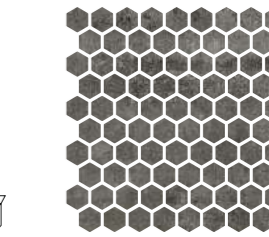
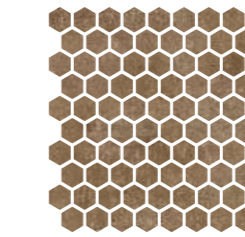
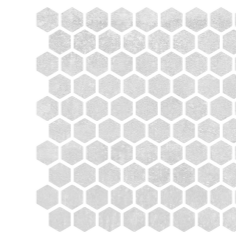
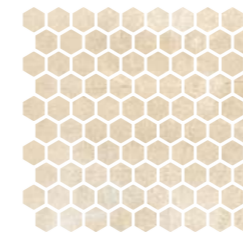
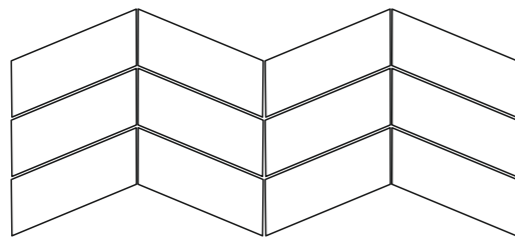
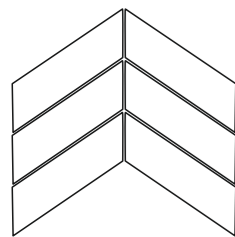

Mosaici Chevron 2
20.5x20.8
770775 Always Marfil
770776 Always Blanco
770777 Always Moka
770778 Always Negro

Mosaici Chevron 4
45.8x16.2
770779 Always Marfil Moka
770780 Always Blanco Negro

Mosaici Hex 9
29.4x29.8
770751 Always Marfil

Mosaici Hex 9
29.4x29.8
770752 Always Blanco

Mosaici Hex 9
29.4x29.8
770753 Always Moka

Mosaici Hex 9
29.4x29.8
770754 Always Negro

A991



rivestimento Always Marfil 80x160
pavimento Always Moka 80x160



rivestimento Always Moka 80x80, Always Marfil 40x80
pavimento Always Moka 80x160



rivestimento Always Marfil 40x80

Grés Porcellanàto . Stoneware Porcelain . Ceràme Gres . Gres Porcelánico

Grés Porcellanàto . Stoneware Porcelain . Ceràme Gres . Gres Porcelánico

Mòsaici . Mosaics . Mosaïques . Mosàicós

Mòsaici . Mosaics . Mosaïques . Mosàicós

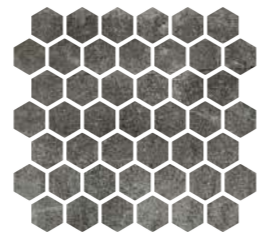
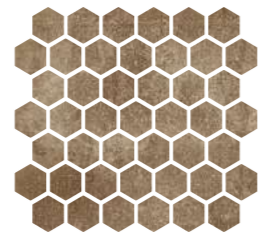
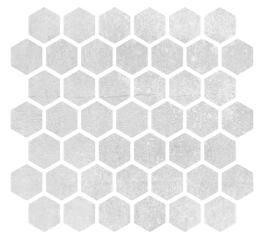
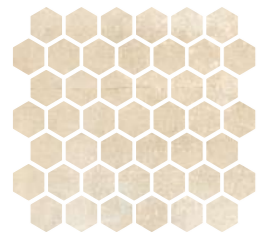

Mosaici Hex 6
30.1x29.8
770755 Always Marfil

Mosaici Hex 6
30.1x29.8
770756 Always Blanco

Mosaici Hex 6
30.1x29.8
770757 Always Moka

Mosaici Hex 6
30.1x29.8
770758 Always Negro

A991

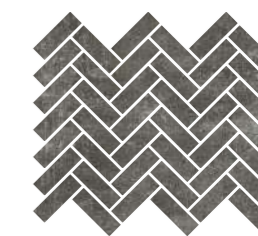
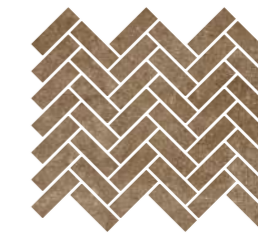
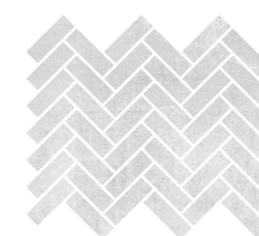

Mosaici Herringbone 6
30x30
770767 Always Marfil

Mosaici Herringbone 6
30x30
770768 Always Blanco

Mosaici Herringbone 6
30x30
770769 Always Moka

Mosaici Herringbone 6
30x30
770770 Always Negro

A992

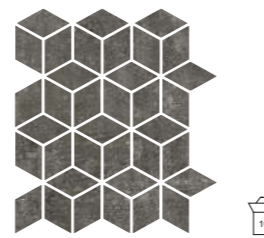
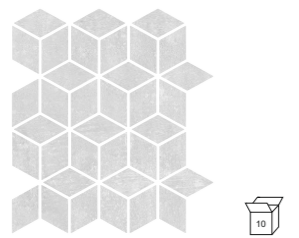
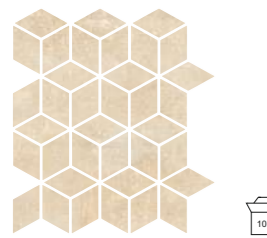

Mosaici Topaz
34.6x30
770759 Always Marfil

Mosaici Topaz
34.6x30
770760 Always Blanco

Mosaici Topaz
34.6x30
770761 Always Moka

Mosaici Topaz
34.6x30
770762 Always Negro

A992

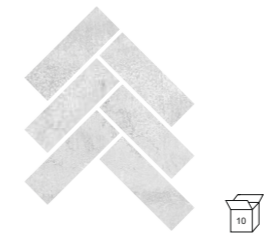

Mosaici Herringbone 2
30x30
770771 Always Marfil

Mosaici Herringbone 2
30x30
770772 Always Blanco

Mosaici Herringbone 2
30x30
770773 Always Moka

Mosaici Herringbone 2
30x30
770774 Always Negro

A993

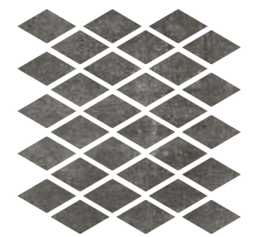
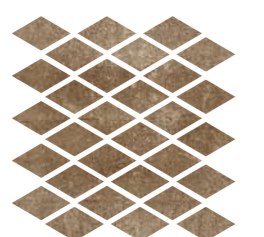
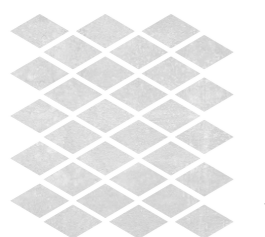
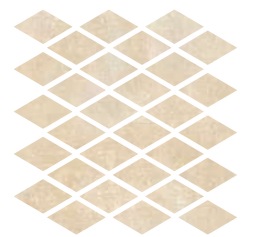

Mosaici Prism
29x30
770763 Always Marfil

Mosaici Prism
29x30
770764 Always Blanco

Mosaici Prism
29x30
770765 Always Moka

Mosaici Prism
29x30
770766 Always Negro

A992

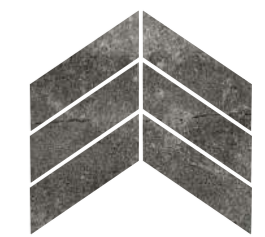
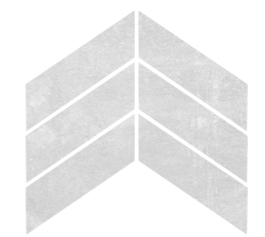

Mosaici Chevron 2
30x30
770775 Always Marfil

Mosaici Chevron 2
30x30
770776 Always Blanco

Mosaici Chevron 2
30x30
770777 Always Moka

Mosaici Chevron 2
30x30
770778 Always Negro

A993

Grés Porcellanato . Stoneware Porcelain . Ceràme Gres . Gres Porcelánico

Mòsaici . Mosaics . Mosaïques . Mosàicós



Mosaici Chevron 4
30x30
770779 Always Marfil Moka









Mosaici Chevron 4
30x30
770780 Always Bianco Negro

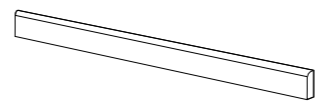



A993

Pezzi speciali . Trims . Pièces spéciales . Formstücke . Piezas especiales .

	 BATTISCOPA	 GRADINO	 SCALINO
	100x1600	300x1600	200x1600
	A139 	A159 	A149 
MARFIL	770781	770785	770789
BIANCO	770782	770786	770790
MOKA	770783	770787	770791
NEGRO	770784	770788	770792

Imballi . Packing . Conditionnement . Verpackungseinheiten . Embalajes .

















FORMATO SIZE FORMAT FORMAT FORMATO	SPESSORE THICKNESS EPAISSEUR STÄRKE ESPESOR	KG/MQ KG/SQM KG/MC KG/QM KG/MQ	SCATOLA BOX BOÎTE KARTON CAJA КОРБОКА	EUROPALLET		
				mq	box	mq
80x160 . 32"x64"	9 mm . 0,35"	45	2	2.56	23	58.88
40x160 . 16"x64"	9 mm . 0,35"	45	4	2.56	23	58.88
20x160 . 8"x64"	9 mm . 0,35"	45	8	2.56	23	58.88
10x120 . 4"x64"	9 mm . 0,35"	45	16	2.56	23	58.88
80x80 . 32"x32"	9 mm . 0,35"	42	3	1.92	34	61.44
40x80 . 16"x32"	9 mm . 0,35"	42	6	1.92	34	61.44
20x80 . 8"x32"	9 mm . 0,35"	42	12	1.92	34	61.44
10x80 . 4"x32"	9 mm . 0,35"	42	24	1.92	34	61.44
70x80 . 28"x32"	9 mm . 0,35"	42	3	1.92	34	61.44
30x30 . 12"x12"	9 mm . 0,35"	30	10	-	-	-

Decorazione a base di rete. -Mesh based Decor. -Decor a base de maille. -Decoracion a base de malla

CARATTERISTICHE TECNICHE

Technical specifications | Technische Eigenschaften | Caractéristiques techniques | Características técnicas |

STANDARD EN 14411 - G

	CARATTERISTICHE TECNICHE TECHNICAL DATA TECHNISCHE DATEN CARACTERISTIQUES TECHNIQUES	NORMA STANDARD NORM NORME	VALORI PRESCRITTI DALLE NORME EN 14411 - G INTERNATIONAL STANDARDS EN 14411 - G INTERNATIONALE NORMWERTE EN 14411 - G VALEURS PREVUES PAR LES NORMES EN 14411 - G	VALORE MEDIO CERAGRES CERAGRES AVERAGE VALUE CERAGRES MITTELWERT VALEURS MOYEN CERAGRES
	CARATTERISTICHE DIMENSIONALI - SIZE CHARACTERISTICS - MASSEIGENSCHAFTEN DETERMINATION DES CARACTERISTIQUES DIMENSIONNELLES - CARACTERÍSTICAS DIMENSIONALES - РАЗМЕРНЫЕ ХАРАКТЕРИСТИКИ - 尺寸特征			NAT (UGL)
	LATI SIDES - SEITEN COTES - CANTOS РАЗМЕРЫ СТОРОН - 側邊	EN ISO 10545-2	± 0,3% MAX (± 1,0 mm MAX)	CONFORME COMPLYING
	SPESORE THICKNESS - DICKE EPAISSEUR - ESPESOR ТОЛЩИНА - 厚度	EN ISO 10545-2	± 5,0% MAX (± 0,5 mm MAX)	CONFORME COMPLYING
	RETTILINEITÀ DEGLI SPIGOLI STRAIGHTNESS OF SIDES - GERADLINIGKEIT DER KANTEN RECTITUDE DES ARETES - RECTITUD DE LOS CANTOS КОСОУГОЛЬНОСТЬ - 边角平直度	EN ISO 10545-2	± 0,3% MAX (± 0,8 mm MAX)	CONFORME COMPLYING
	ORTOGONALITÀ RECTANGULARITY - RECHTWINKLIGKEIT PERPENDICULARITÉ - ORTOGONALIDAD КРИВИЗНА СТОРОН - 直角度	EN ISO 10545-2	± 0,3% MAX (± 1,5 mm MAX)	CONFORME COMPLYING
	PLANARITÀ SURFACE FLATNESS - EBENFLÄCHIGKEIT PLANEITE DE SURFACE - PLANEIDAD КРИВИЗНА ЛИЦЕВОЙ ПОВЕРХНОСТИ - 平整度	EN ISO 10545-2	± 0,4% MAX (± 1,8 mm MAX)	CONFORME COMPLYING
	ASSORBIMENTO D'ACQUA WATER ABSORPTION - WASSERAUFNAHME ABSORPTION D'EAU - ABSORCIÓN DE AGUA ВОДОПОГЛОЩЕНИЕ - 吸水率	EN ISO 10545-3	≤ 0,5%	≤ 0,1%
	RESISTENZA ALLA FLESSIONE FLEXION RESISTANCE - BIEGEFESTIGKEIT RESISTANCE A LA FLEXION - RESISTENCIA A LA FLEXIÓN ПРЕДЕЛ ПРОЧНОСТИ ПРИ ИЗГИБЕ - 抗弯强度	EN ISO 10545-4	S ≥ 700 N (< 7,5 mm) S ≥ 1.300 N (> 7,5 mm) R ≥ 35 N/mm².	S ≥ 2.800 N R ≥ 49 N/mm² (formato 600x600 24"x24" size)
	RESISTENZA ALL'URTO IMPACT RESISTANCE - STOSSFESTIGKEIT RESISTANCE AUX CHOCES - RESISTENCIA A LOS GOLPES УДАРОСТОЙКОСТЬ - 抗冲击强度	EN ISO 10545-5	VALORE DICHIARATO DECLARED VALUE	> 0,80
	RESISTENZA ALL'ABRASIONE ABRASION RESISTANCE - ABRIEFESTIGKEIT RESISTANCE A L'ABRASION - RESISTENCIA A LA ABRASIÓN СТОЙКОСТЬ К ИСТИРАНИЮ - 耐磨强度	EN ISO 10545-6	≤ 175 mm³	< 150 mm³
	COEFFICIENTE DI DILATAZIONE TERMICA LINEARE COEFFICIENT OF LINEAR THERMAL-EXPANSION - LINEARER WÄRMEAUDEHNUNGSKOEFFIZIENT COEFFICIENT DE DILATATION THERMIQUE LINEAIRE - COEFICIENTE DE DILATACIÓN TÉRMICA LINEAL КОЭФИЦИЕНТ ЛИНЕЙНОГО ТЕРМИЧЕСКОГО РАСШИРЕНИЯ - 线性热膨胀系数	EN ISO 10545-8	-	α=7,3x10 ⁻⁶ °C ⁻¹
	RESISTENZA AGLI SBALZI TERMICI RESISTANCE TO THERMAL SHOCKS - BESTÄNDIGKEIT GEGEN TEMPERATURSCHWANKUNGEN RESISTANCE AUX CHOCES THERMIQUES - RESISTENCIA A LOS CHOQUES TÉRMICOS СТОЙКОСТЬ К ПЕРЕПАДАМ ТЕМПЕРАТУРЫ - 耐热突变性	EN ISO 10545-9	TEST SUPERATO SECONDO EN ISO 10545-1 PASS ACCORDING EN ISO 10545-1	NESSUN DANNO NO DAMAGE
	RESISTENZA AL GELO FROST RESISTANCE - FROSTBESTÄNDIGKEIT RESISTANCE AU GEL - RESISTENCIA AL HIELO МОРОЗОСТОЙКОСТЬ - 耐冻性	EN ISO 10545-12	TEST SUPERATO SECONDO EN ISO 10545-1 PASS ACCORDING EN ISO 10545-1	NESSUN DANNO NO DAMAGE
	RESISTENZA ALL'ATTACCO CHIMICO RESISTANCE TO CHEMICALS - CHEMIKALIENBESTÄNDIGKEIT RESISTANCE A L'ATTAQUE CHIMIQUE - RESISTENCIA QUÍMICA ХИМИЧЕСКАЯ СТОЙКОСТЬ - 耐化学品作用	EN ISO 10545-13	UB MIN.	UA ULA UHA
	RESISTENZA ALLE MACCHIE RESISTANCE TO STAINS - FLECKENBESTÄNDIGKEIT RESISTANCE AUX TACHES - RESISTENCIA A LAS MANCHAS УСТОЙЧИВОСТЬ К ПЯТНООБРАЗОВАНИЮ - 防污性	EN ISO 10545-14	VALORE DICHIARATO DECLARED VALUE	5
	CESSIONE DI PIOMBO E CADMIO LEAD AND CADMIUM DISCHARGE - ABGABE VON BLEI UND CADMIUM PERTÉ DE PLOMB ET CADMIUM - CESIÓN DE PLOMO Y CADMIO ВЫДЕЛЕНИЕ СВИНЦА И КАДМИЯ - 铅和镉的排放	EN ISO 10545-15	VALORE DICHIARATO DECLARED VALUE	< AL LIMITE DI RILEVAMENTO < THAN INSTRUMENT LIMIT
				NAT
		DM. 236/89 BCRA	> 0,40	> 0,40
		ASTM C1028	SCOF > 0,60	> 0,60
		ANSI A137.1	Wet DCOF > 0,42	> 0,42
		AS 4586:2013	-	-
		DIN 51130	-	R9
		DIN 51097	-	-
		ENV 12633	≥ CL1	CL1
		BS 7976	≥ 36	≥ 36
	SCIVOLOSITÀ SKID RESISTANCE - RUTSCHWERT GLISSANCE - ADHERENCIA			



touch@ceragresceramics.com
www.ceragresceramics.com